

# Switch-mode Schottky Power Rectifier 250 V, 40 A

## MBR40250G, MBR40250TG, MBRF40250TG, MBRB40250TG

### Features

- 250 V Blocking Voltage
- Low Forward Voltage Drop,  $V_F = 0.86$  V
- Soft Recovery Characteristic,  $T_{RR} < 35$  ns
- Stable Switching Performance Over Temperature
- These Devices are Pb-Free and are RoHS Compliant

### Benefits

- Reduces or Eliminates Reverse Recovery Oscillations
- Minimizes Need for EMI Filtering
- Reduces Switching Losses
- Improved Efficiency

### Applications

- Power Supply
- Power Management
- Automotive
- Instrumentation

### Mechanical Characteristics

- Case: Epoxy, Molded
- Weight: 1.9 grams (approximately)
- Finish: All External Surfaces Corrosion Resistant and Terminal Leads are Readily Solderable
- Lead Temperature for Soldering Purposes:  
260°C Max. for 10 Seconds
- Epoxy Meets UL 94 V-0 at 0.125 in



ON Semiconductor®

[www.onsemi.com](http://www.onsemi.com)

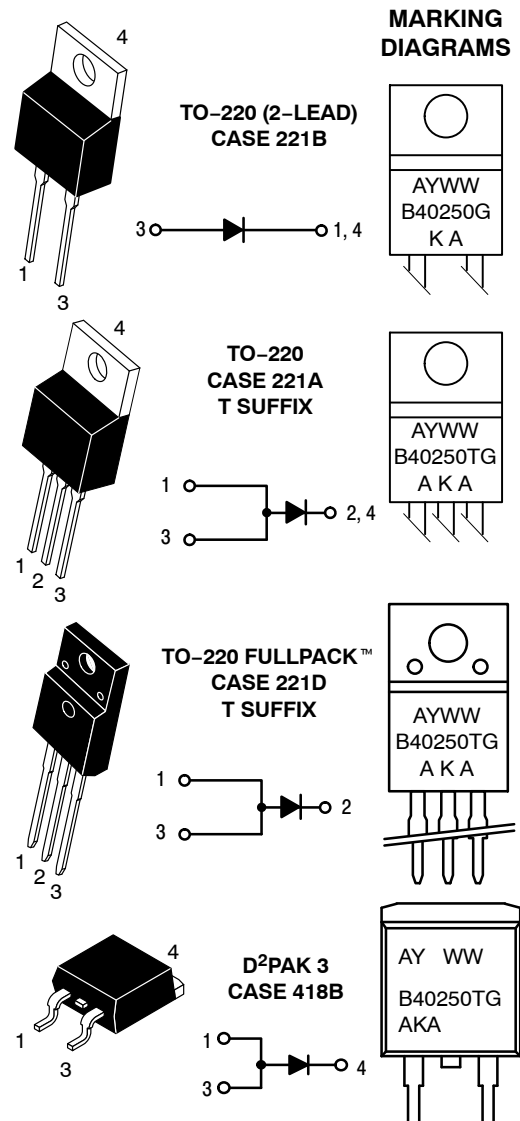

B40250 = Device Code  
 T = 3 pins  
 A = Assembly Location  
 Y = Year  
 WW = Work Week  
 G = Pb-Free Package  
 KA, AKA = Polarity Designator

### ORDERING INFORMATION

See detailed ordering and shipping information on page 4 of this data sheet.

# MBR40250G, MBR40250TG, MBRF40250TG, MBRB40250TG

## MAXIMUM RATINGS

Rating	Symbol	Value	Unit
Peak Repetitive Reverse Voltage Working Peak Reverse Voltage DC Blocking Voltage	$V_{RRM}$ $V_{RWM}$ $V_R$	250	V
Average Rectified Forward Current (Rated $V_R$ ) $T_C = 82^\circ\text{C}$ MBR40250, MBR40250T, MBRB40250T (Rated $V_R$ ) $T_C = 46^\circ\text{C}$ MBRF40250T	$I_{F(AV)}$	40	A
Peak Repetitive Forward Current (Rated $V_R$ , Square Wave, 20 kHz) $T_C = 82^\circ\text{C}$ MBR40250, MBR40250T, MBRB40250T (Rated $V_R$ , Square Wave, 20 kHz) $T_C = 46^\circ\text{C}$ MBRF40250T	$I_{FRM}$	80	A
Nonrepetitive Peak Surge Current (Surge applied at rated load conditions halfwave, single phase, 60 Hz)	$I_{FSM}$	150	A
Storage Temperature	$T_{stg}$	-65 to +175	$^\circ\text{C}$
Operating Junction Temperature	$T_J$	-65 to +150	$^\circ\text{C}$
Voltage Rate of Change (Rated $V_R$ )	dv/dt	10,000	V/ $\mu\text{s}$

Stresses exceeding those listed in the Maximum Ratings table may damage the device. If any of these limits are exceeded, device functionality should not be assumed, damage may occur and reliability may be affected.

## THERMAL CHARACTERISTICS

Characteristic	Symbol	Value	Unit
Maximum Thermal Resistance Junction-to-Case MBR40250(T) and MBRB40250T MBRF40250	$R_{\theta JC}$	2.0 3.0	$^\circ\text{C}/\text{W}$
Junction-to-Ambient MBR40250(T) MBRF40250 MBRB40250T	$R_{\theta JA}$	60 50 50	

## ELECTRICAL CHARACTERISTICS

Characteristic	Symbol	Value	Unit
Maximum Instantaneous Forward Voltage (Note 1) $I_F = 20\text{ A}$ , $T_C = 25^\circ\text{C}$ $I_F = 20\text{ A}$ , $T_C = 125^\circ\text{C}$ $I_F = 40\text{ A}$ , $T_C = 25^\circ\text{C}$ $I_F = 40\text{ A}$ , $T_C = 125^\circ\text{C}$	$V_F$	0.86 0.71 0.97 0.86	V
Maximum Instantaneous Reverse Current (Note 1) Rated DC Voltage, $T_C = 25^\circ\text{C}$ Rated DC Voltage, $T_C = 125^\circ\text{C}$	$I_R$	0.25 30	mA
Maximum Reverse Recovery Time $I_F = 1.0\text{ A}$ , di/dt = 50 A/ $\mu\text{s}$ , $T_C = 25^\circ\text{C}$	$t_{rr}$	35	ns

## DYNAMIC CHARACTERISTICS

Characteristic	Symbol	Value	Unit
Capacitance $V_R = -5.0\text{ V}$ , $T_C = 25^\circ\text{C}$ , Frequency = 1.0 MHz	$C_T$	500	pF

Product parametric performance is indicated in the Electrical Characteristics for the listed test conditions, unless otherwise noted. Product performance may not be indicated by the Electrical Characteristics if operated under different conditions.

1. Pulse Test: Pulse Width = 300  $\mu\text{s}$ , Duty Cycle  $\leq 2.0\%$ .

# MBR40250G, MBR40250TG, MBRF40250TG, MBRB40250TG

## TYPICAL CHARACTERISTICS

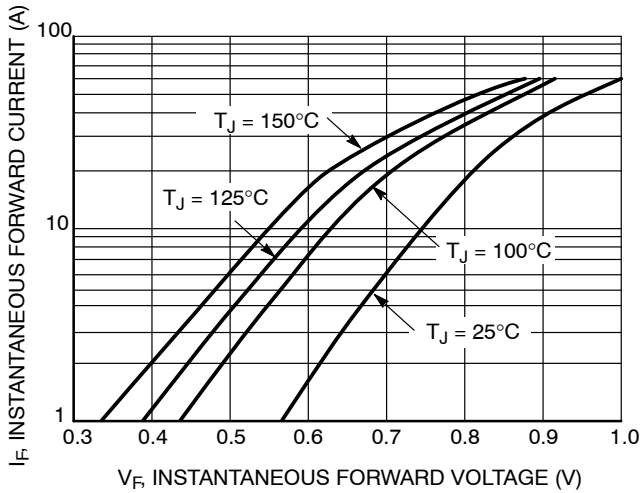

Figure 1. Typical Forward Voltage

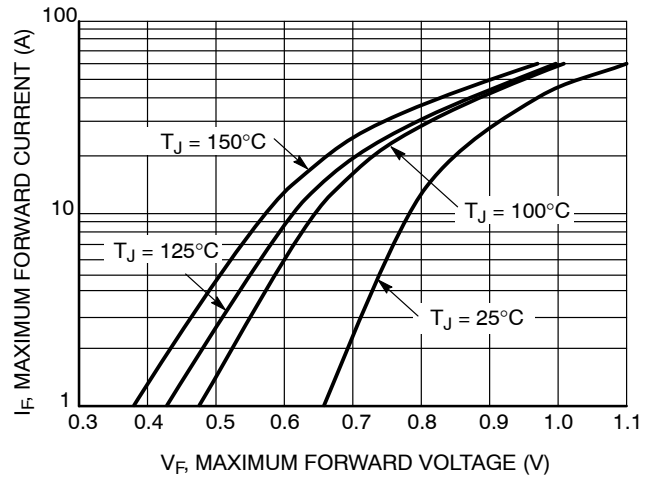

Figure 2. Maximum Forward Voltage

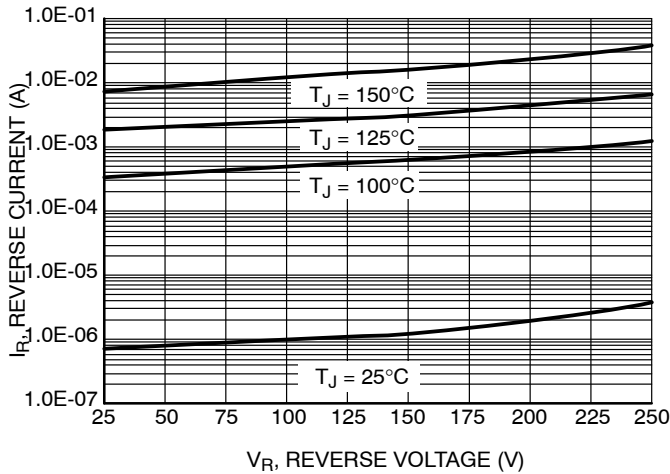

Figure 3. Typical Reverse Current

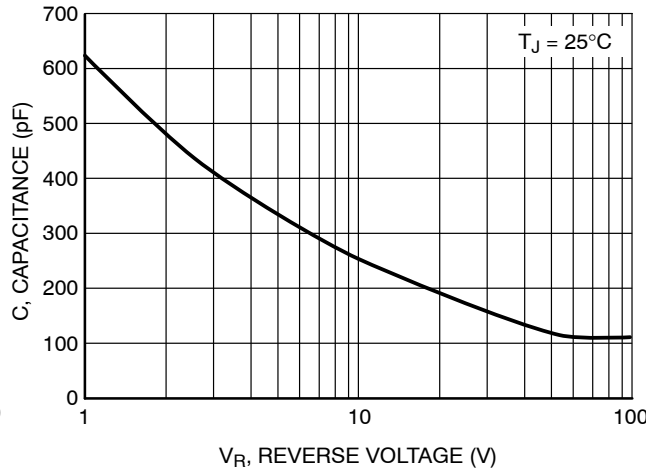

Figure 4. Typical Capacitance

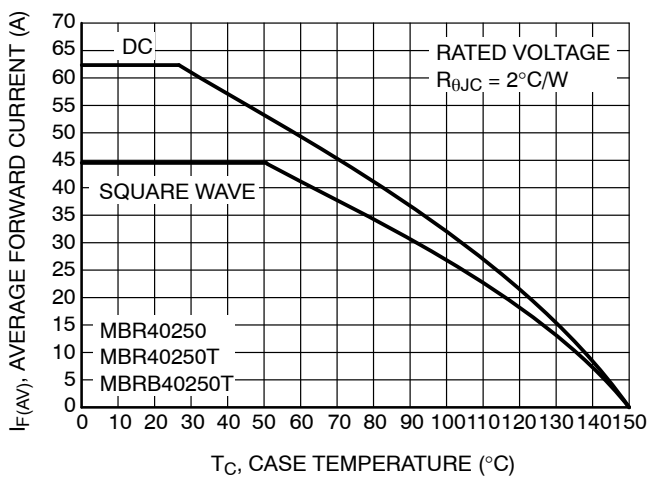

Figure 5. Current Derating (Case) for MBR40250, MBR40250T and MBRB40250T

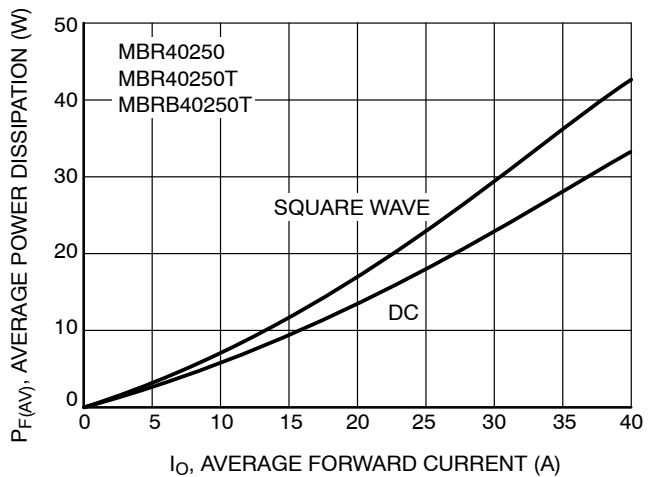

Figure 6. Forward Power Dissipation for MBR40250, MBR40250T and MBRB40250T

# MBR40250G, MBR40250TG, MBRF40250TG, MBRB40250TG

## TYPICAL CHARACTERISTICS

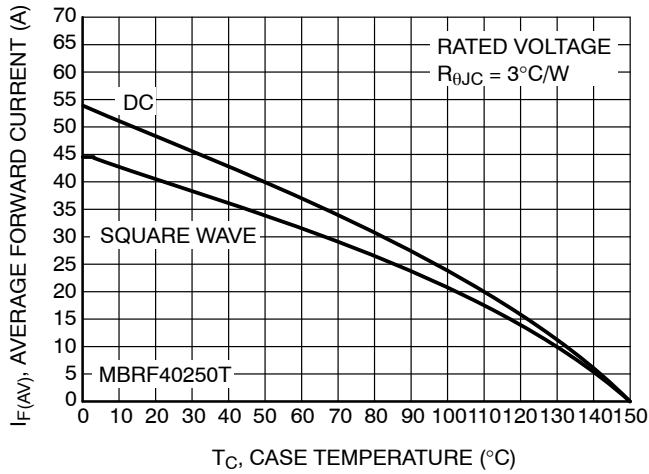

Figure 7. Current Derating (Case) for MBRF40250T

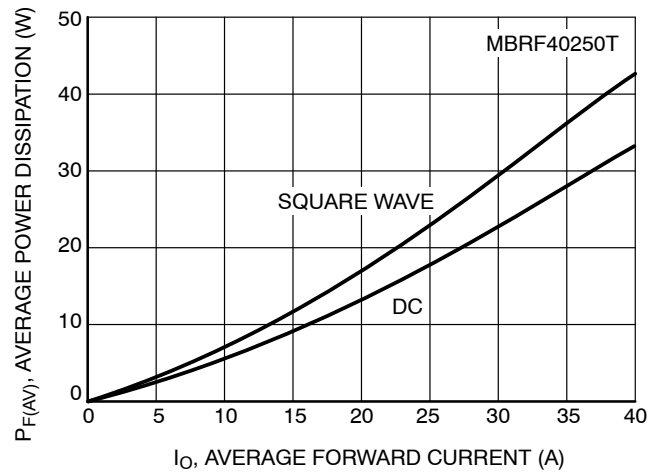

Figure 8. Forward Power Dissipation for MBRF40250T

### ORDERING INFORMATION

Device	Package	Shipping†
MBR40250G	TO-220 (2-LEAD) (Pb-Free)	50 Units / Rail
MBR40250TG	TO-220 (Pb-Free)	50 Units / Rail
MBRF40250TG	TO-220 FULLPACK (Pb-Free)	50 Units / Rail
MBRB40250TG	D <sup>2</sup> PAK 3 (Pb-Free)	50 Units / Rail
MBRB40250TT4G	D <sup>2</sup> PAK 3 (Pb-Free)	800 Units / Tape & Reel

†For information on tape and reel specifications, including part orientation and tape sizes, please refer to our Tape and Reel Packaging Specifications Brochure, BRD8011/D.

# MECHANICAL CASE OUTLINE PACKAGE DIMENSIONS

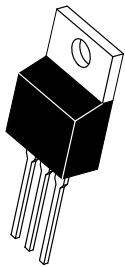

SCALE 1:1

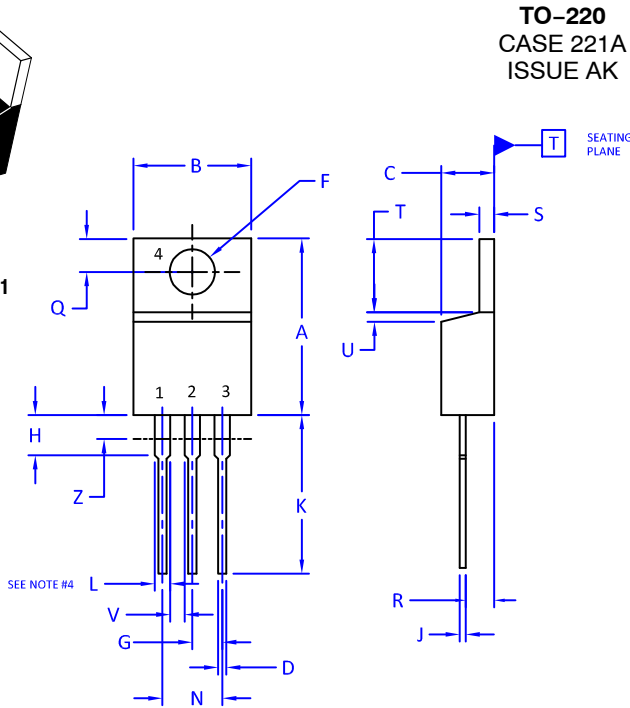

## TO-220 CASE 221A ISSUE AK

DATE 13 JAN 2022

NOTES:

1. DIMENSIONING AND TOLERANCING PER ANSI Y14.5M, 2009.
2. CONTROLLING DIMENSION: INCHES
3. DIMENSION Z DEFINES A ZONE WHERE ALL BODY AND LEAD IRREGULARITIES ARE ALLOWED.
4. MAX WIDTH FOR F102 DEVICE = 1.35MM

DIM	INCHES		MILLIMETERS	
	MIN.	MAX.	MIN.	MAX.
A	0.570	0.620	14.48	15.75
B	0.380	0.415	9.66	10.53
C	0.160	0.190	4.07	4.83
D	0.025	0.038	0.64	0.96
F	0.142	0.161	3.60	4.09
G	0.095	0.105	2.42	2.66
H	0.110	0.161	2.80	4.10
J	0.014	0.024	0.36	0.61
K	0.500	0.562	12.70	14.27
L	0.045	0.060	1.15	1.52
N	0.190	0.210	4.83	5.33
Q	0.100	0.120	2.54	3.04
R	0.080	0.110	2.04	2.79
S	0.045	0.055	1.15	1.41
T	0.235	0.255	5.97	6.47
U	0.000	0.050	0.00	1.27
V	0.045	---	1.15	---
Z	---	0.080	---	2.04

STYLE 1:  
PIN 1. BASE  
2. COLLECTOR  
3. EMITTER  
4. COLLECTOR

STYLE 2:  
PIN 1. BASE  
2. EMITTER  
3. COLLECTOR  
4. EMITTER

STYLE 3:  
PIN 1. CATHODE  
2. ANODE  
3. GATE  
4. ANODE

STYLE 4:  
PIN 1. MAIN TERMINAL 1  
2. MAIN TERMINAL 2  
3. GATE  
4. MAIN TERMINAL 2

STYLE 5:  
PIN 1. GATE  
2. DRAIN  
3. SOURCE  
4. DRAIN

STYLE 6:  
PIN 1. ANODE  
2. CATHODE  
3. ANODE  
4. CATHODE

STYLE 7:  
PIN 1. CATHODE  
2. ANODE  
3. CATHODE  
4. ANODE

STYLE 8:  
PIN 1. CATHODE  
2. ANODE  
3. EXTERNAL TRIP/DELAY  
4. ANODE

STYLE 9:  
PIN 1. GATE  
2. COLLECTOR  
3. EMITTER  
4. COLLECTOR

STYLE 10:  
PIN 1. GATE  
2. SOURCE  
3. DRAIN  
4. SOURCE

STYLE 11:  
PIN 1. DRAIN  
2. SOURCE  
3. GATE  
4. SOURCE

STYLE 12:  
PIN 1. MAIN TERMINAL 1  
2. MAIN TERMINAL 2  
3. GATE  
4. NOT CONNECTED

DOCUMENT NUMBER:	98ASB42148B	Electronic versions are uncontrolled except when accessed directly from the Document Repository. Printed versions are uncontrolled except when stamped "CONTROLLED COPY" in red.
DESCRIPTION:	TO-220	PAGE 1 OF 1

onsemi and onsemi are trademarks of Semiconductor Components Industries, LLC dba onsemi or its subsidiaries in the United States and/or other countries. onsemi reserves the right to make changes without further notice to any products herein. onsemi makes no warranty, representation or guarantee regarding the suitability of its products for any particular purpose, nor does onsemi assume any liability arising out of the application or use of any product or circuit, and specifically disclaims any and all liability, including without limitation special, consequential or incidental damages. onsemi does not convey any license under its patent rights nor the rights of others.

# MECHANICAL CASE OUTLINE

## PACKAGE DIMENSIONS



### TO-220, 2-LEAD CASE 221B-04 ISSUE F

DATE 12 APR 2013

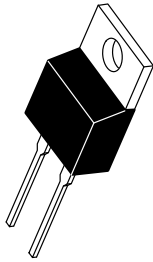

SCALE 1:1

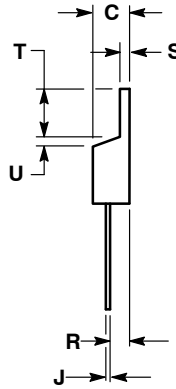
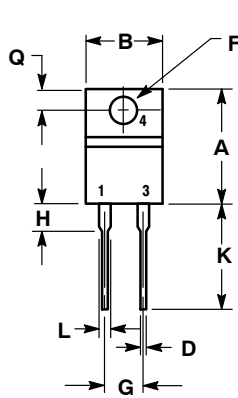

NOTES:

1. DIMENSIONING AND TOLERANCING PER ANSI Y14.5M, 1982.
2. CONTROLLING DIMENSION: INCH.

DIM	INCHES		MILLIMETERS	
	MIN	MAX	MIN	MAX
A	0.595	0.620	15.11	15.75
B	0.380	0.405	9.65	10.29
C	0.160	0.190	4.06	4.82
D	0.025	0.039	0.64	1.00
F	0.142	0.161	3.61	4.09
G	0.190	0.210	4.83	5.33
H	0.110	0.130	2.79	3.30
J	0.014	0.025	0.36	0.64
K	0.500	0.562	12.70	14.27
L	0.045	0.060	1.14	1.52
Q	0.100	0.120	2.54	3.04
R	0.080	0.110	2.04	2.79
S	0.045	0.055	1.14	1.39
T	0.235	0.255	5.97	6.48
U	0.000	0.050	0.000	1.27

STYLE 1:  
PIN 1. CATHODE  
2. N/A  
3. ANODE  
4. CATHODE

STYLE 2:  
PIN 1. ANODE  
2. N/A  
3. CATHODE  
4. ANODE

<b>DOCUMENT NUMBER:</b>	<b>98ASB42149B</b>	Electronic versions are uncontrolled except when accessed directly from the Document Repository. Printed versions are uncontrolled except when stamped "CONTROLLED COPY" in red.
<b>DESCRIPTION:</b>	<b>TO-220, 2-LEAD</b>	<b>PAGE 1 OF 1</b>

ON Semiconductor and are trademarks of Semiconductor Components Industries, LLC dba ON Semiconductor or its subsidiaries in the United States and/or other countries. ON Semiconductor reserves the right to make changes without further notice to any products herein. ON Semiconductor makes no warranty, representation or guarantee regarding the suitability of its products for any particular purpose, nor does ON Semiconductor assume any liability arising out of the application or use of any product or circuit, and specifically disclaims any and all liability, including without limitation special, consequential or incidental damages. ON Semiconductor does not convey any license under its patent rights nor the rights of others.

# MECHANICAL CASE OUTLINE PACKAGE DIMENSIONS

ON Semiconductor®

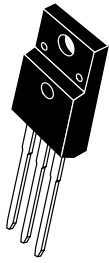

SCALE 1:1

## TO-220 FULLPAK CASE 221D-03 ISSUE K

DATE 27 FEB 2009

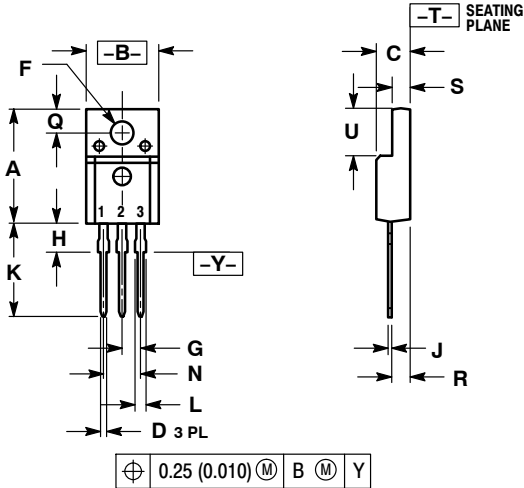

- NOTES:
1. DIMENSIONING AND TOLERANCING PER ANSI Y14.5M, 1982.
  2. CONTROLLING DIMENSION: INCH
  3. 221D-01 THRU 221D-02 OBSOLETE, NEW STANDARD 221D-03.

DIM	INCHES		MILLIMETERS	
	MIN	MAX	MIN	MAX
A	0.617	0.635	15.67	16.12
B	0.392	0.419	9.96	10.63
C	0.177	0.193	4.50	4.90
D	0.024	0.039	0.60	1.00
F	0.116	0.129	2.95	3.28
G	0.100 BSC		2.54 BSC	
H	0.118	0.135	3.00	3.43
J	0.018	0.025	0.45	0.63
K	0.503	0.541	12.78	13.73
L	0.048	0.058	1.23	1.47
N	0.200 BSC		5.08 BSC	
Q	0.122	0.138	3.10	3.50
R	0.099	0.117	2.51	2.96
S	0.092	0.113	2.34	2.87
U	0.239	0.271	6.06	6.88

### MARKING DIAGRAMS

- |  |   |  |
|--|---|--|
| STYLE 1:<br>PIN 1. GATE<br>2. DRAIN<br>3. SOURCE     | STYLE 2:<br>PIN 1. BASE<br>2. COLLECTOR<br>3. EMITTER | STYLE 3:<br>PIN 1. ANODE<br>2. CATHODE<br>3. ANODE |
| STYLE 4:<br>PIN 1. CATHODE<br>2. ANODE<br>3. CATHODE | STYLE 5:<br>PIN 1. CATHODE<br>2. ANODE<br>3. GATE     | STYLE 6:<br>PIN 1. MT 1<br>2. MT 2<br>3. GATE      |



**Bipolar**

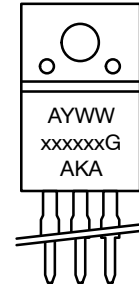

**Rectifier**

- |                               |                           |
|-------------------------------|---------------------------|
| xxxxxx = Specific Device Code | A = Assembly Location     |
| G = Pb-Free Package           | Y = Year                  |
| A = Assembly Location         | WW = Work Week            |
| Y = Year                      | xxxxxx = Device Code      |
| WW = Work Week                | G = Pb-Free Package       |
|                               | AKA = Polarity Designator |

<b>DOCUMENT NUMBER:</b>	<b>98ASB42514B</b>	Electronic versions are uncontrolled except when accessed directly from the Document Repository. Printed versions are uncontrolled except when stamped "CONTROLLED COPY" in red.
<b>DESCRIPTION:</b>	<b>TO-220 FULLPAK</b>	<b>PAGE 1 OF 1</b>

ON Semiconductor and are trademarks of Semiconductor Components Industries, LLC dba ON Semiconductor or its subsidiaries in the United States and/or other countries. ON Semiconductor reserves the right to make changes without further notice to any products herein. ON Semiconductor makes no warranty, representation or guarantee regarding the suitability of its products for any particular purpose, nor does ON Semiconductor assume any liability arising out of the application or use of any product or circuit, and specifically disclaims any and all liability, including without limitation special, consequential or incidental damages. ON Semiconductor does not convey any license under its patent rights nor the rights of others.

# MECHANICAL CASE OUTLINE

## PACKAGE DIMENSIONS

ON Semiconductor®

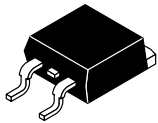

**D<sup>2</sup>PAK 3**  
CASE 418B-04  
ISSUE L

DATE 17 FEB 2015

SCALE 1:1

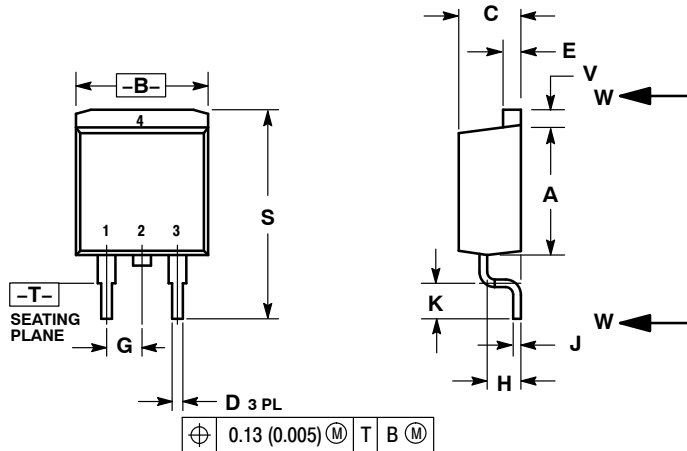

**NOTES:**

1. DIMENSIONING AND TOLERANCING PER ANSI Y14.5M, 1982.
2. CONTROLLING DIMENSION: INCH.
3. 418B-01 THRU 418B-03 OBSOLETE, NEW STANDARD 418B-04.

DIM	INCHES		MILLIMETERS	
	MIN	MAX	MIN	MAX
A	0.340	0.380	8.64	9.65
B	0.380	0.405	9.65	10.29
C	0.160	0.190	4.06	4.83
D	0.020	0.035	0.51	0.89
E	0.045	0.055	1.14	1.40
F	0.310	0.350	7.87	8.89
G	0.100	BSC	2.54	BSC
H	0.080	0.110	2.03	2.79
J	0.018	0.025	0.46	0.64
K	0.090	0.110	2.29	2.79
L	0.052	0.072	1.32	1.83
M	0.280	0.320	7.11	8.13
N	0.197	REF	5.00	REF
P	0.079	REF	2.00	REF
R	0.039	REF	0.99	REF
S	0.575	0.625	14.60	15.88
V	0.045	0.055	1.14	1.40

**VARIABLE CONFIGURATION ZONE**

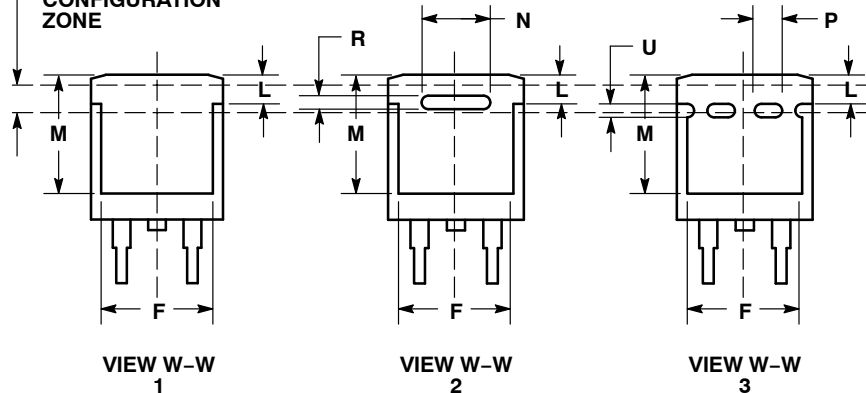

- |  |   |   |  |   |  |
|--|---|---|--|---|--|
| <b>STYLE 1:</b><br>PIN 1. BASE<br>2. COLLECTOR<br>3. EMITTER<br>4. COLLECTOR | <b>STYLE 2:</b><br>PIN 1. GATE<br>2. DRAIN<br>3. SOURCE<br>4. DRAIN | <b>STYLE 3:</b><br>PIN 1. ANODE<br>2. CATHODE<br>3. ANODE<br>4. CATHODE | <b>STYLE 4:</b><br>PIN 1. GATE<br>2. COLLECTOR<br>3. EMITTER<br>4. COLLECTOR | <b>STYLE 5:</b><br>PIN 1. CATHODE<br>2. ANODE<br>3. CATHODE<br>4. ANODE | <b>STYLE 6:</b><br>PIN 1. NO CONNECT<br>2. CATHODE<br>3. ANODE<br>4. CATHODE |
|--|---|---|--|---|--|

**MARKING INFORMATION AND FOOTPRINT ON PAGE 2**

<b>DOCUMENT NUMBER:</b>	<b>98ASB42761B</b>	Electronic versions are uncontrolled except when accessed directly from the Document Repository. Printed versions are uncontrolled except when stamped "CONTROLLED COPY" in red.
<b>DESCRIPTION:</b>	<b>D<sup>2</sup>PAK 3</b>	<b>PAGE 1 OF 2</b>

ON Semiconductor and are trademarks of Semiconductor Components Industries, LLC dba ON Semiconductor or its subsidiaries in the United States and/or other countries. ON Semiconductor reserves the right to make changes without further notice to any products herein. ON Semiconductor makes no warranty, representation or guarantee regarding the suitability of its products for any particular purpose, nor does ON Semiconductor assume any liability arising out of the application or use of any product or circuit, and specifically disclaims any and all liability, including without limitation special, consequential or incidental damages. ON Semiconductor does not convey any license under its patent rights nor the rights of others.



**D<sup>2</sup>PAK 3**  
CASE 418B-04  
ISSUE L

DATE 17 FEB 2015

**GENERIC  
MARKING DIAGRAM\***

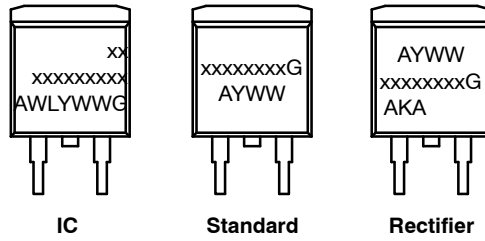

- xx = Specific Device Code
- A = Assembly Location
- WL = Wafer Lot
- Y = Year
- WW = Work Week
- G = Pb-Free Package
- AKA = Polarity Indicator

\*This information is generic. Please refer to device data sheet for actual part marking. Pb-Free indicator, "G" or microdot "▪", may or may not be present.

**SOLDERING FOOTPRINT\***



DIMENSIONS: MILLIMETERS

\*For additional information on our Pb-Free strategy and soldering details, please download the ON Semiconductor Soldering and Mounting Techniques Reference Manual, SOLDERRM/D.

<b>DOCUMENT NUMBER:</b>	<b>98ASB42761B</b>	Electronic versions are uncontrolled except when accessed directly from the Document Repository. Printed versions are uncontrolled except when stamped "CONTROLLED COPY" in red.
<b>DESCRIPTION:</b>	<b>D<sup>2</sup>PAK 3</b>	<b>PAGE 2 OF 2</b>

ON Semiconductor and are trademarks of Semiconductor Components Industries, LLC dba ON Semiconductor or its subsidiaries in the United States and/or other countries. ON Semiconductor reserves the right to make changes without further notice to any products herein. ON Semiconductor makes no warranty, representation or guarantee regarding the suitability of its products for any particular purpose, nor does ON Semiconductor assume any liability arising out of the application or use of any product or circuit, and specifically disclaims any and all liability, including without limitation special, consequential or incidental damages. ON Semiconductor does not convey any license under its patent rights nor the rights of others.

**onsemi**, **Onsemi**, and other names, marks, and brands are registered and/or common law trademarks of Semiconductor Components Industries, LLC dba "**onsemi**" or its affiliates and/or subsidiaries in the United States and/or other countries. **onsemi** owns the rights to a number of patents, trademarks, copyrights, trade secrets, and other intellectual property. A listing of **onsemi**'s product/patent coverage may be accessed at [www.onsemi.com/site/pdf/Patent-Marking.pdf](http://www.onsemi.com/site/pdf/Patent-Marking.pdf). **onsemi** reserves the right to make changes at any time to any products or information herein, without notice. The information herein is provided "as-is" and **onsemi** makes no warranty, representation or guarantee regarding the accuracy of the information, product features, availability, functionality, or suitability of its products for any particular purpose, nor does **onsemi** assume any liability arising out of the application or use of any product or circuit, and specifically disclaims any and all liability, including without limitation special, consequential or incidental damages. Buyer is responsible for its products and applications using **onsemi** products, including compliance with all laws, regulations and safety requirements or standards, regardless of any support or applications information provided by **onsemi**. "Typical" parameters which may be provided in **onsemi** data sheets and/or specifications can and do vary in different applications and actual performance may vary over time. All operating parameters, including "Typicals" must be validated for each customer application by customer's technical experts. **onsemi** does not convey any license under any of its intellectual property rights nor the rights of others. **onsemi** products are not designed, intended, or authorized for use as a critical component in life support systems or any FDA Class 3 medical devices or medical devices with a same or similar classification in a foreign jurisdiction or any devices intended for implantation in the human body. Should Buyer purchase or use **onsemi** products for any such unintended or unauthorized application, Buyer shall indemnify and hold **onsemi** and its officers, employees, subsidiaries, affiliates, and distributors harmless against all claims, costs, damages, and expenses, and reasonable attorney fees arising out of, directly or indirectly, any claim of personal injury or death associated with such unintended or unauthorized use, even if such claim alleges that **onsemi** was negligent regarding the design or manufacture of the part. **onsemi** is an Equal Opportunity/Affirmative Action Employer. This literature is subject to all applicable copyright laws and is not for resale in any manner.

## PUBLICATION ORDERING INFORMATION

### LITERATURE FULFILLMENT:

Email Requests to: [orderlit@onsemi.com](mailto:orderlit@onsemi.com)

**onsemi Website:** [www.onsemi.com](http://www.onsemi.com)

### TECHNICAL SUPPORT

**North American Technical Support:**  
Voice Mail: 1 800-282-9855 Toll Free USA/Canada  
Phone: 011 421 33 790 2910

**Europe, Middle East and Africa Technical Support:**

Phone: 00421 33 790 2910

For additional information, please contact your local Sales Representative