

Product Manual of TFmini-S

TFmini-S LiDAR Module

www.benewake.com
Benewake (Beijing) Co., Ltd.



Specified Product

Product model: TFmini-S

Product name: TFmini-S LiDAR Module

Manufacturer

Company name: Benewake (Beijing) Co. Ltd.

Address: No.28, Xinxu Road, Haidian District, Beijing, PRC

Copyright

The Copyright of this document is protected. All the rights involved herein belong to Benewake (Beijing) Co. Ltd. Any copy activity of this document, no matter in whole or in part, should be in conformity of the Copyright Law. The actives of Modification, omission or translation of this document are not allowed unless a written permission from Benewake (Beijing) Co. Ltd.

All rights reserved © Benewake (Beijing) Co. Ltd.

Product Certification



Foreword

Dear users,

Thanks for choosing Benewake products, and it's our pleasure to help you to solve any technical question.

In the purpose of offering a better operation experience to you, we hereby write this manual for an easier and simpler operation of our product, hoping to better solve the common problems you maybe meet.

This operation manual covers the product operation introduction and common problem solutions, but it is really hard to covers all the problems you maybe meet. So, if you have any further questions or problems, please feel free to consult our technical support service (support@benewake.com). We will do our best to solve any problem related to the product. If you have any other good advice or suggestion, welcome to visit our official website and offer us your feedback there (http://en.benewake.com/contact_us), and we are looking forwards to your participation.

We are Benewake who dedicated to making the best “Robotic Eyes” worldwide!

Table of Contents

1 ATTENTIONS	6
1.1 ABOUT THIS MANUAL	6
1.2 USAGE OF PRODUCT	6
1.3 CONDITIONS WITH POTENTIAL MALFUNCTION	6
2 DESCRIPTION	6
2.1 PRODUCT DESCRIPTION	6
2.2 PRINCIPLE OF DISTANCE MEASUREMENT	7
2.3 MAIN CHARACTERISTIC PARAMETERS	7
2.4 REPEATABILITY	8
2.5 DISTANCE MEASUREMENT CHARACTERISTICS	8
3 APPEARANCE AND STRUCTURE	9
3.1 PRODUCT APPEARANCE AND STRUCTURE	9
4 ELECTRICAL CHARACTERISTICS	10
5 LINE SEQUENCE AND DATA COMMUNICATION PROTOCOL	10
5.1 DESCRIPTION ABOUT LINE SEQUENCE AND CONNECTION	10
5.2 SERIAL PORT COMMUNICATION PROTOCOL	11
5.3 DATA OUTPUT FORMAT OF SERIAL PORT	11
5.4 DESCRIPTIONS OF DEFAULT OUTPUT DATA.....	12
5.5 I ² C DATA COMMUNICATION	12
5.6 TIMING SEQUENCE DESCRIPTION OF I ² C MODE	12
5.7 I/O MODE DESCRIPTION	13
6 QUICK TEST	13
6.1 REQUIRED TOOLS OF PRODUCT TEST	13
6.2 TEST PROCEDURES	13

7	DESCRIPTIONS ON PARAMETER CONFIGURATION	15
7.1	FUNCTION OVERVIEW.....	15
7.2	COMMAND CONVENTION	16
7.3	COMMAND FRAME DEFINITION	16
7.4	GENERAL PARAMETER CONFIGURATION AND DESCRIPTION	16
8	REMOTE UPGRADING.....	18
9	MALFUNCTION: CAUSES AND TROUBLESHOOTING.....	19
10	Q&A	21
	ATTACHMENT 1: INTRODUCTION OF TF SERIES PC SOFTWARE	22



1 Attentions

1.1 About this Manual

- This manual provides all the essential information during the usage of this product.
- Please carefully read this manual and make sure that you fully understand everything herein.

1.2 Usage of Product

- The maintenance of this product should be done by the professional technician, and the product can only work with the factory spare part for ensuring the performance and safety.
- This product itself has no polarity and over-voltage protection. Please properly connect and supply power as described in this manual.
- Operating temperature of this product is between 0°C and 60°C. Do not use it beyond this temperature range to prevent malfunction.
- Storage temperature of this product is between -20°C and 75°C. Do not store it beyond this temperature range to prevent malfunction.
- For ensuring the product performance, do not open the product shell or remove the IR-pass filter.

1.3 Conditions with Potential Malfunction

- Detecting object with high reflectivity, such as the mirror or the smooth floor tile, may cause a system malfunction.
- The product will malfunction if there is any transparent object between it and the detecting object, such as glass or water.
- The product will be subject to risk of failure if its transmitting or receiving lens is covered by the dust. Please keep the lens clean.
- Please do not directly touch circuit board of the product by hand as it is exposed. Please wear antistatic wrist strap or glove if necessary; Otherwise, the product will be subject to risk of failure, which is shown by failure of normal operation, and even it will be broken.

2 Description

2.1 Product description

TFmini-S is an upgrade project based on TFmini. It is a miniaturized, single-point ranging product. Based on the TOF (time of flight) principle, it is designed with unique optics, electricity, and algorithms to achieve stability, precision, sensitivity and high-speed distance measurement function.



In addition to the low-cost, small-size, and long-ranging of the TFmini, the product itself has higher distance measurement accuracy. It is more adaptable to different outdoor environments such as strong light, different temperatures, and different reflectances. It has lower power consumption and more flexible detection frequency. The product is compatible with both the UART and I²C interface. Different interfaces can be switched by commands.

2.2 Principle of Distance Measurement

TFmini-S is based on TOF (Time of Flight). To be specific, the product emits modulation wave of near infrared ray on a periodic basis, which will be reflected after contacting object. The product obtains the time of flight by measuring round-trip phase difference and then calculates relative range between the product and the detection object, as shown in Figure 1.

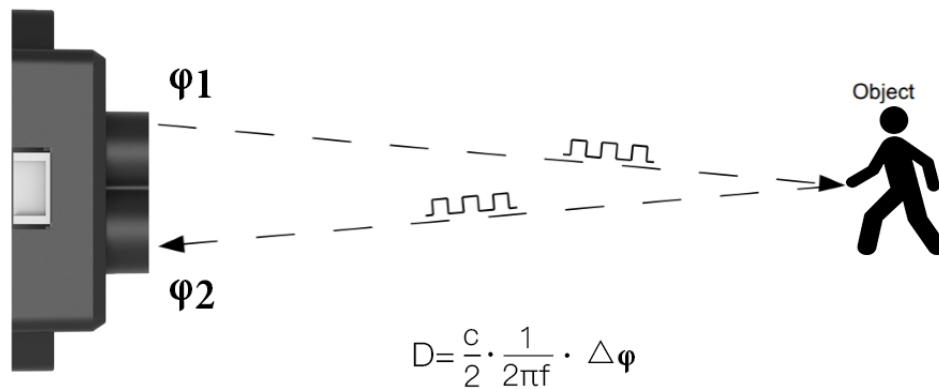

Figure 1 Schematics of TOF Principle

2.3 Main Characteristic Parameters

Table 1 Main Characteristic Parameters of TFmini-S

Description	Parameter value
Operating range	0.1m~12m ^①
Accuracy	±6cm@ (0.1-6m) ^②
	±1%@ (6m-12m)
Measurement unit	cm
Range resolution	1cm
FOV	2° ^③
Frame rate	1~1000Hz (adjustable) ^④

① Operating range based on a standard whiteboard with 90% reflectivity in indoor condition

② The distance measurement here is absolute accuracy, and the specific repeat accuracy will be described in section 2.4.

③ 2° is the theoretical value, from which the actual value will be different.

④ Only frame rates meeting the formula - 1000/n (n is positive integer) can be set. The default frame rate is 100Hz.



2.4 Repeatability

The repeat accuracy of TFmini-S is directly related to the Strength value measured and the output frame rate (Frequency). The ranging repeat accuracy is characterized by the standard deviation of ranging. When the frame rate is 100 Hz, the standard deviation of ranging is as follows under the background of 90% transmittance:

Table 2 Statistics: the standard deviation of TFmini-S at 100Hz and 90% reflectivity

Dist	2m	4m	6m	8m	10m
STD	0.5cm	1cm	1.5cm	2cm	2.5cm

2.5 Distance Measurement Characteristics

With optimization of light path and algorithm, TFmini-S has minimized influence from external environment on distance measurement performance. Despite that, the range of distance measurement may still be affected by the environment illumination intensity and the reflectivity of detection object. The detection blind zone of TFmini-S, 0-10cm, within which the output data is unreliable.

The operating range of TFmini-S detecting black target with 10% reflectivity, 0.1-5m.

The operating range of TFmini-S detecting white target with 90% reflectivity, 0.1-12m.

The diameter of light spot depends on the FOV of TFmini-S (the term of FOV generally refers to the smaller value between the receiving angle and the transmitting angle), which is calculated as follows:

$$d = 2 * D * \tan\beta$$

In the formula above, d is the diameter of light spot; D is detecting range; β is the the value of the half receiving angle of TFmini-S, 1°. Correspondence between the diameter of light spot and detecting range is given in Table 3.

Table 3 the Minimum side length of effective detection corresponding to Detecting Range

Detecting range	1m	2m	3m	4m	5m	6m	7m	8m	9m	10m	11m	12m
Minimum side length	3.5cm	7cm	10.5cm	14cm	17.5cm	21cm	24.5cm	28cm	31.5cm	35cm	38.5cm	42cm





If the light spot reaches two objects with different distances, as shown in Figure 2, the output distance value will be a value between the actual distance values of the two objects. For a high accuracy requirement in practice, the above situation should be noticed to avoid the measurement error.

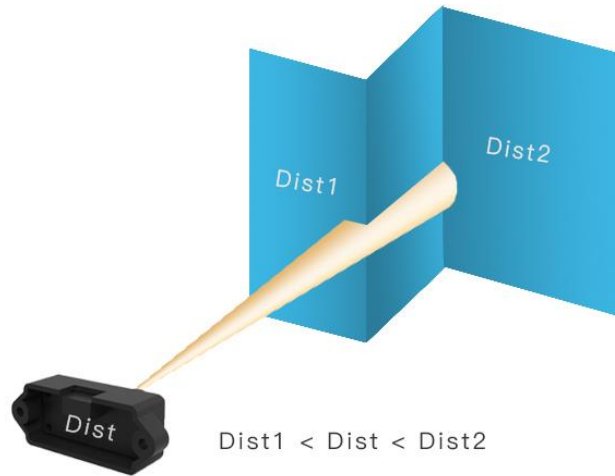

Figure 2 Distance Measurement in the case of Two Objects of Different Distances

3 Appearance and Structure

3.1 Product Appearance and Structure

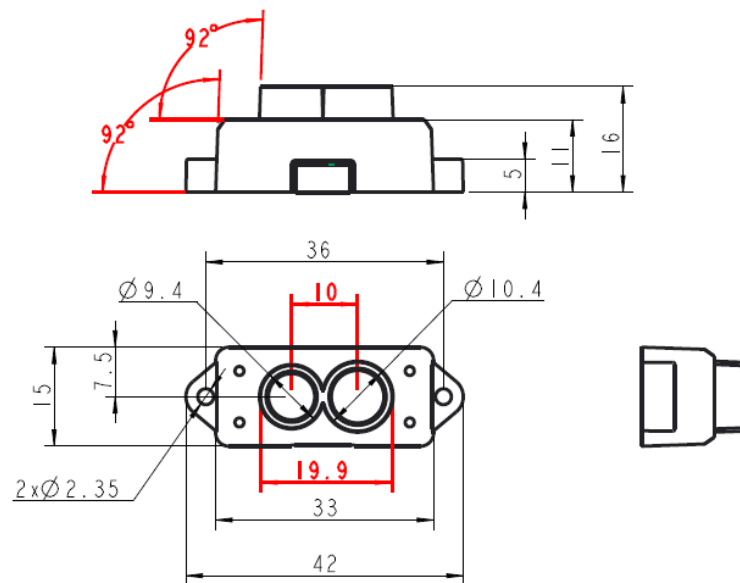

Figure 3: Dimension of TFmini-S(Unit:mm)



4 Electrical Characteristics

Table 4: Major Electrical Parameters of TFmini-S

Description	Parameter value
Supply voltage	5V±0.1V
Average current	≤140mA
Peak current	200mA
Average power	700mW
Communication level	LVTTL (3.3V)

This product has no overvoltage nor polarity protection, so please make sure that connection and power supply are normal. The fluctuation of the power supply voltage in a range of ±0.1V is allowable.

Average current varies along with the operating modes of the product in two patterns, more specifically, its current is around 50mA under short distance mode and it is around 140mA under long distance mode.

5 Line Sequence and Data Communication Protocol

5.1 Description about Line Sequence and Connection

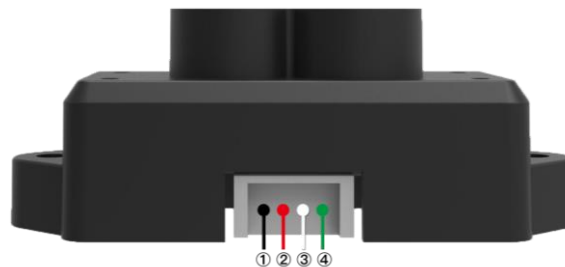

Table5: The Function and Connection Description of each pin

No.	Color	Function	Comment
①	Black	GND	Ground
②	Red	+5V	Power supply
③	White	RXD/SDA	Receiving/Data
④	Green	TXD/SCL	Transmitting/Clock

Type of connecting terminal: GH1.25-4P. The product includes a 10cm long connecting wire, the other end of which is a conventional 1.25-4p terminal (Molex510210400). The user may extend this wire as he/she needs. In order to ensure effective data transmission, it is recommended that the length of the connecting wire welded by the user should be less than 1m.



5.2 Serial port Communication Protocol

TFmini-S adopts the serial port data communication protocol, as given in Table 6.

Table 6 Data Communication Protocol of TFmini-S——UART

Communication interface	UART
Default baud rate	115200
Data bit	8
Stop bit	1
Parity check	None

5.3 Data Output Format of Serial port

TFmini-S is available with two formats of data output, namely, the standard data output format and the character string data format, both of which are switchable with command.

- **Standard data output format (default):**

Data structure: each data frame contains 9 bytes, including the distance value, signal strength, temperature of chip and data check byte (Checksum), etc. Data format is hexadecimal (HEX). Data codes are detailed in Table 7:

Table 7 Data Format and Code Explanation

Byte0 -1	Byte2	Byte3	Byte4	Byte5	Byte6	Byte7	Byte8
0x59 59	Dist_L	Dist_H	Strength_L	Strength_H	Temp_L	Temp_H	Checksum
Data code explanation							
Byte0	0x59, frame header, same for each frame						
Byte1	0x59, frame header, same for each frame						
Byte2	Dist_L distance value low 8 bits						
Byte3	Dist_H distance value high 8 bits						
Byte4	Strength_L low 8 bits						
Byte5	Strength_H high 8 bits						
Byte6	Temp_L low 8 bits						
Byte7	Temp_H high 8 bits						
Byte8	Checksum is the lower 8 bits of the cumulative sum of the numbers of the first 8 bytes.						

- **Character string data format**

The data output is in the format of character string and its unit is m(meter). For example, if the measurement distance is 1.21m, the string 1.21 will be output, followed by the escape character `\r\n`.



5.4 Descriptions of default Output Data

Dist(Distance): Represents the output of the distance value detected by TFmini-S, with the unit in cm by default. This value is interpreted into the decimal value in the range of 0-1200. When the signal strength is lower than 100, the detection is unreliable, TFmini-S will set distance value to -1. Abnormal data values are detailed in Table 8.

Strength: Represents the signal strength with the default value in the range of 0-65535. After the distance mode is set, the longer the measurement distance is, the lower the signal strength will be; the lower the reflectivity is, the lower the signal strength will be.

Temp(Temperature): Represents the chip temperature of TFmini-S. Degree centigrade = Temp / 8 - 256

Table 8 Description of abnormal data values

Dist	Strength	Comment
-1	Other value	Strength ≤ 100
-2	-1	Signal strength saturation
-4	Other value	Ambient light saturation

5.5 I²C data communication

Table 9 Data Communication Protocol of TFmini-S—I²C

Interface	I ² C
Max transmission rate	400kbps
Master/slave mode	Slave mode
Default address	0x10
Address range	0x01~0x7F

5.6 Timing sequence description of I²C mode

Different from the serial mode, the I²C communication is initiated by the master. TFmini-S as the slave, can only send and receive data passively. After the sending the config-frame from the master to the slave, one needs to wait for a period for the command to be processed. Then read feedback operation, the suggested waiting period is 100ms. The two commands "Restore Factory Settings" and "Save Current Settings" involve data storage operations, and the recommended waiting time is 2s. To ensure the real-time



performance in the ranging state, the “acquired ranging result” data frame requires a short waiting time. It is recommended to wait for 1ms and then read the result after sending commands.

In order to ensure that the ranging result is read correctly, it is necessary to set the frame rate of the radar to be greater than or equal to 2.5 times the frame rate of the I²C reading ranging result by the command "ID_SAMPLE_FREQ=0x03". Data are detailed in Table 10.

Table 10 Timing sequence of the I²C mode

Start	Addr	W	A	Byte0	A	---	ByteN	A	Stop	Wait 100ms	Start	Addr	R	A	Byte0	A	---	ByteN	A	Stop
-------	------	---	---	-------	---	-----	-------	---	------	------------	-------	------	---	---	-------	---	-----	-------	---	------

5.7 I/O mode description

I/O output mode is supported and could be enabled by related command. See detail in chapter 7.4.Command open mode (Mode), critical distance (Dist) and hysteresis zone (Zone) could be configurable:

Mode: 0(data output mode), 1(I/O mode, high level near and low level far), 2(I/O mode, low level near and high level far); default value is 0.





Dist: critical value, near end value in hysteresis zone, unit is cm, default number is 0.

Zone: hysteresis zone range, unit is cm; default value is 0(there is no hysteresis zone)

The hysteresis zone could be set by this command, when output is near zone level, output will be switched to far zone level if measured result is higher than far end point; when output is far zone level, output is switched to near zone level if measured result is lower than near end point.(high level:3.3V,low level:0V)

6 Quick Test

6.1 Required Tools of Product Test

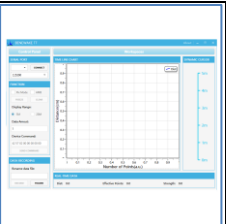
					
TFmini-S	Data wire	TTL - USB converter	USB cable	PC	PC software

6.2 Test Procedures

- ① Download the Test software

Please download the Test software of TFmini-S at our official website (en.benewake.com).



Caution: please shut down any anti-virus software before uncompressing the PC software. Otherwise, maybe the software is deleted as virus. The software is only runnable under Windows environment for the time being. Please refer to Attachment 1 - Product manual of TF Test software.

② Connection of the hardware

Connect “TFmini-S”, “TTL - USB board” and “USB cable” as shown in Figure 4. Make sure there is no loose connection. Then connect “USB cable” with “PC”.



Figure 4 Schematic Diagram of Correct Connection

③ Connection to the Test software and data output

Open the PC software and select “① TFmini” and select automatically recognized occupied serial port (here it is “② COM9”), as shown in Figure 5

Then click “CONNECT”. Upon successful connection, The continuous images of the output data will be displayed in area “④ TIME LINE CHART” on the right. Besides, the real-time data of the Current measure distance (Dist), effective data points per second (Effective Points) and signal strength (Strength) will be displayed in area “⑥ REAL TIME DATA” below.

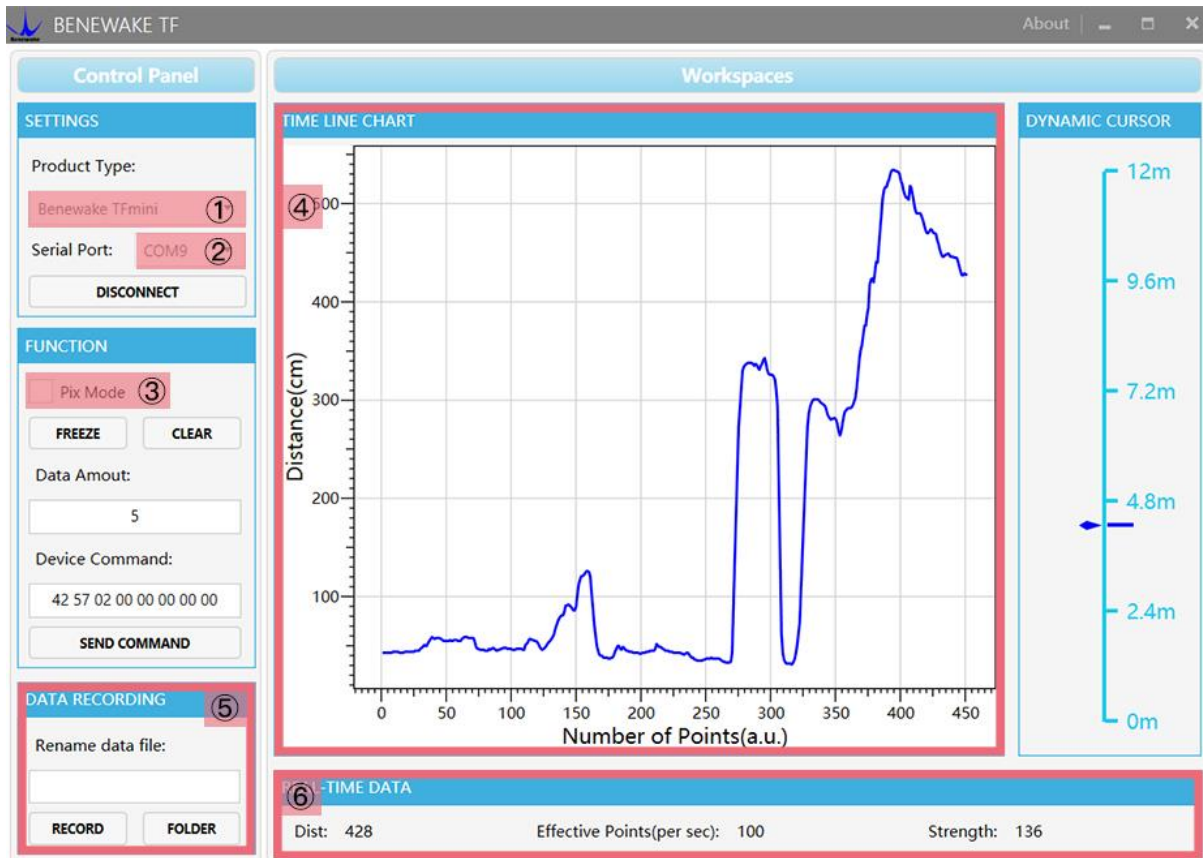

Figure 5 Software Interface and Display

Notes:

- If no data is available in area “④TIME LINE CHART”, please check the line connection and line sequence. When TFmini-S is successfully powered on, there will be a red indicator light inside transmitting lens viewing from the front.
- If the user want the TFmini-S output in the Pixhawk format, please select “③Pix Mode” at first, otherwise area “④TIME LINE CHART” will not output the right data image normally. After Pix Mode is checked, the unit of distance will be changed into m automatically.
- The value of distance output Dist may vary with the output unit, which is cm by default. If the unit of distance is changed to the unit-mm with specific command, and the PC software will be unable to identify it, and so the unit of “④TIME LINE CHART” will still be cm. For example, the actual TFmini-S measurement is 1m, the distance value of TFmini-S is 1000 in mm, the value read by the PC software also is 1000, but the unit will not change and still display cm.

7 Descriptions on Parameter Configuration

7.1 Function Overview

The function of user-defined configuration of product parameters is hereby enabled for more flexible settlement of your problems by TFmini-S. User may modify original parameters by sending relevant commands, such as output data format and frame rate, etc.



Please modify product configuration depending upon your actual demands. Do not frequently try irrelevant commands to prevent incorrect sending of command which many cause unnecessary loss. Please make sure to make the configuration as the commands listed herein. Do not send unstated command.

7.2 Command Convention

- 1) Multi-bytes data or command frame is transmitted in little endian format.

For example, decimal number 1000 can be transferred to 0x03E8 in hexadecimal. Then it will be saved in the data or command frame as:

0x5A 0x06 0x03 0xE8 0x03 0x4E

- 2) Command: data instruction frame sent from PC to LiDAR.
- 3) Response: data instruction frame uploaded from LiDAR to host computer or other terminal

7.3 Command Frame Definition

Caution: All configuration commands are sent as hexadecimal digits (HEX).

Table 11 Command frame definition

Byte0	Byte1	Byte2	Byte3 ~ ByteN-2	ByteN-1
Head	Len	ID	Payload	Checksum
Remarks				
Byte0	Head: frame header (0x5A)			
Byte1	Len: the total length of the frame (include Head and Checksum, unit: byte)			
Byte2	ID: identifier code of command			
Byte3-N-2	Data: data segment. Little endian format			
ByteN-1	Checksum: sum of all bytes from Head to payload. Lower 8 bits			

7.4 General Parameter Configuration and Description

Before setting the relevant parameters of TFmini-S, user needs to establish the connection between TFmini-S and PC at first. About the connection details, refer to the test connection given in Chapter [6.2](#). User can send the relevant configuration-related instructions to the product via TFmini-S PC software or other serial port debugging software. All commands are compatible with both the UART mode and the I²C mode.

Important: After setting parameters, the ‘Save setting’ command needs to be sent.



Table 12 General Parameter Configuration and Description

Parameters	Command	Response	Remark	Default setting
Obtain firmware version	5A 04 01 5F	5A 07 01 V1 V2 V3 SU	Version V3.2.1	
System reset	5A 04 02 60	5A 05 02 00 60	Succeeded	/
		5A 05 02 01 61	Failed	/
Frame rate	5A 06 03 LL HH SU	5A 06 03 LL HH SU	1-1000Hz ^①	100Hz
Trigger detection	5A 04 04 62	Data frame	After setting the frame rate to 0, detection can be triggered with this command	
Output format	5A 05 05 01 65	5A 05 05 01 65	Standard 9 bytes(cm)	√
	5A 05 05 02 66	5A 05 05 02 66	Pixhawk	/
	5A 05 05 06 6A	5A 05 05 06 6A	Standard 9 bytes (mm)	/
Baud rate	5A 08 06 H1 H2 H3 H4 SU	5A 08 06 H1 H2 H3 H4 SU	Set baud rate ^②	115200
Enable/Disable output	5A 05 07 00 66	5A 05 07 00 66	Disable data output	/
	5A 05 07 01 67	5A 05 07 01 67	Enable data output	√
Communication interface setup	5A 05 0A MODE SU	/	0 (UART) 1 (I ² C)	UART
Modify slave address of I ² C	5A 05 0B ADDR SU	5A 05 0B ADDR SU	Modify I2c_slave_addr	0x10
Obtain Data Frame	5A 05 00 01 60	Data Frame(9bytes-cm)	Only works in I2C mode	/
	5A 05 00 06 65	Date Frame(9bytes-mm)		



I/O mode enable	5A 09 3B MODE DL DH ZoneL ZoneH SU	/	Open or close I/O output mode MODE: 0--standard data mode 1--I/O,near high and far low 2--I/O,near low and far high Zone:hysteresis zone	0(standard data mode)
Restore factory settings	5A 04 10 6E	5A 05 10 00 6E	Succeeded	
		5A 05 10 01 6F	Failed	
Save settings	5A 04 11 6F ^③	5A 05 11 00 6F	Succeeded	
		5A 05 11 01 70	Failed	

Note: Bytes with yellow undertone represents checksum. Bytes with blue undertone represents data segment.

- ① The default update rate is 100Hz. The customized update rate should be calculated by the formula: $1000/n$ (n is positive integer). Increasing frame rate will decrease the data stability.
- ② Only standard baud rates are supported. When setting a high update rate, a high baud rate is recommended to ensure data security.
- ③ Please always send the command of save settings when try to modify parameters of TFmini-S, otherwise the settings will not take effect

8 Remote Upgrading

TFmini-S supports the remote upgrade. When the user's product cannot satisfy the current application requirements and Benewake official website has relevant firmware upgrades, the user may upgrade the product firmware via remotely upgrading the PC software. Please contact us to get the Updater



The tools for the firmware upgrade of TFmini-S are mostly the same as the [Quick Test](#), which requires one TTL-USB board to connect the TFmini-S with PC.

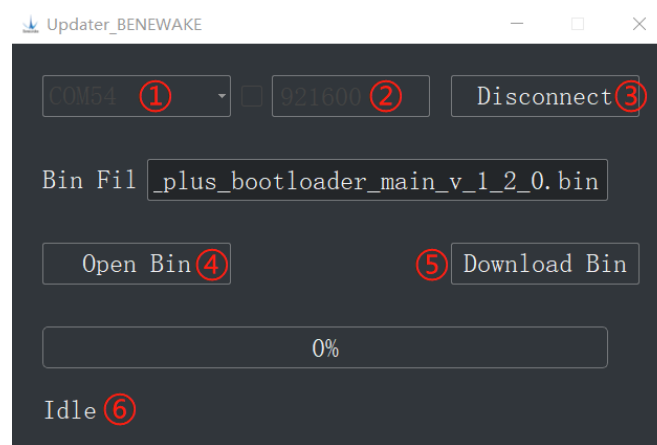

Figure 6 Upgrade tool of TFmini-S

Upon successful connection, open the Updater.exe. Select right port, here is “①COM8”. Input the right baud rate in “② 115200” and click “③ CONNECT” to connect the TFmini-S with the Updater. Click “④ Open Bin” to choose the updating firmware, whose directory will be showed in the textbox above. Then click “⑤ Download Bin” to start upgrading. The information of upgrading will be showed in “⑥”.

Caution: Remote upgrade of the host computer and firmware files need to be placed in the pure English path.

9 Malfunction: Causes and Troubleshooting

(1) Distance value occasionally will abruptly change into -1 beyond the range during normal operation.

Cause: The different test environments (reflectivity of detected object, disturbance of ambient light, etc.) will affect the signal strength of TFmini-S. For a reliable and stable measurement data, the algorithm elimination is internally used for TFmini-S. In case of the insufficient signal strength, TFmini-S will output -1. This value is not measurement data of TFmini-S, which is only used to remind the user that such data is unreliable.

Troubleshooting: please use such value as the trigger signal of some unreliable data, and it will ensure that your system can use other reliable data for further assessment and decision-making if there are some unreliable data.

(2) Significant error between the output distant value of LiDAR and actual distance

Cause ①: Incorrect interpretation of the data communication protocol of TFmini-S.

Troubleshooting: check data communication interpretation means. In case of such error, please check the



data format to adjust interpretation means.

Cause ②: Due to the physical principles of TFmini-S, the above phenomenon is likely to occur if the detection object is the material with high reflectivity (such as mirror, smooth floor tile, etc.) or transparent substance (such as glass and water, etc.)

Troubleshooting: Please avoid use of this product under such circumstance in practice.

Cause ③: The IR-pass filters are blocked.

Troubleshooting: please use dry dust-free cloth to gently remove the foreign matter

(3) No data output

Cause: The product will be strictly inspected before leaving our factory, ensuring that all the shipped products can work normally. However, some abnormal working matters maybe still occur because of incidents during the transportation or use.

Troubleshooting: Check whether the power supply is normal; check whether the voltage is within rated voltage range. If power supply is normal, there will be a red light inside the transmitting lens of TFmini-S.

Check TFmini-S with correct connection sequence and reliable connection.

Check whether the data interpretation is correct. Please carry out the interpretation as per the data format specified herein.

If the problem persists, please contact our technical support.

(4) There is no data output when LiDAR is connected to PC software.

Cause ①: The PC software only supports the Windows operation system for the time being

Troubleshooting: Use the PC supporting Windows operation system.

Cause ②: TTL - USB board is poorly connected.

Troubleshooting: Check the TTL -USB board with the correct and reliable connection with TFmini-S and PC.

Cause ③: Driver of serial port is not correctly installed.

Troubleshooting: Plug and unplug USB cable again. Try to reinstall the driver or directly download and install a driver from the internet.

If the PC software still work abnormally, please contact our technical support.

(5) The accuracy of TFmini-S gets worse at 12m and the data fluctuation becomes larger.



Cause: There are metal objects around the front lens barrel.

Troubleshooting: Remove or replace metal objects near the lens barrel with non-metallic materials. If the metal material around the lens barrel in your installation position cannot be changed, and there are high requirements for data stability and error at the extreme distance, please contact our technical support.

10 Q&A

Q1: Is TFmini-S available with 3.3V or other power supply voltage?

A1: Sorry, it is not available for the time being. The Standard power supply of TFmini-S is $5V \pm 0.1V$. If you have any further requirement, please contact our sales person to consult a customization design matter.

Q2: TFmini-S will heat up after operating for a while. Is it broken?

A2: This is the normal operating condition of the product. The temperature of the chip and circuit board will slightly up after a continuous operation, which is a normal case.

Q3: Can TFmini-S be connected with Arduino or Raspberry Pi for use?

A3: Yes, it can. TFmini-S adopts serial communication protocol so that it can connect to any control board supporting serial port communication.



Attachment 1: Introduction of TF Series PC software

This PC software only supports the Windows operating system. It is suitable for any products of TF series, but the output of those products is limited to the serial port communication protocol. Detailed operations are as below.



Figure 7: Interface of TF Series software

1 Product Type/Serial Port Control Zone [SETTINGS]

Product Type: connect the LiDAR via TTL-USB board to the PC. As shown in the figure, select 'TFmini-S'.

Serial port (COM): select the right serial port number corresponding to the LiDAR. Baud rate is set to 115200 as default.

CONNECT/DISCONNECT: Click [CONNECT] button to establish the connection with LiDAR. Click [DISCONNECT] button to terminate the connection.

2 Function Zone [FUNCTION]

Pix Mode: check the checkbox to enable Pix mode. Uncheck the checkbox will set TFmini-S to default output format. **In Pix mode, the frame rate (Effective Points) calculated by test software is unreliable.**

FREEZE/CLEAR: After clicking [FREEZE], time-line chart in zone [4] will stop updating. On clicking

[CLEAR], the plotted curve in [4] will be cleared.

Frame Rate: choose frame rate from the drop box, setting will be made immediately.

Drawing/Pt: upon receipt of every N frames, the PC software will draw one point on the chart [4] the average of the N data. N can be modified depending upon the actual requirement (the value is preferable to be ≥ 10 to prevent the PC software from lagging). After entering the value, press “Enter” key on the keyboard to enable the setting.

Command: Input the commands in hexadecimal format in the text box and click the [SEND] button above to send the command.

3 Data Recording Zone [DATA RECORDING]

Input the name of data file in the textbox. Press [RECORD] button to start recording data and click the [FINISHED] button to stop recording. Click [FOLDER] button to open the folder where the data file is saved.

Note: when the frame rate of LiDAR is too high, like 1000Hz, the time stamp will be asymmetric due to the massive data stream.

4 Time Line Chart Zone [TIME LINE CHART]

The PC software will draw the continuous distance measurement curves based on the received data, where y-coordinates represent the current distance data while x-coordinates represent effective data.

5 Real-time Data Display Zone [REAL-TIME DATA]

Dist: Distance, cm by default.

Dist(Echo): parameter of TF03. With TFmini-S, the default value is 0.

Effective Points (per sec): indicates effective points refreshed by TF per second (equals to frame rate).

Strength (Signal strength): in pix mode, TFmini-S will not output strength value, so the Strength is 0 by default.

6 Operating Environment and Precautions

Operating Environment: this software can only run on Windows system, Win7 and above. The .Net Framework 4.5.2 is needed to use this software.

Precautions: Please do not directly connect the product with frame rate more than 500Hz to test software, which will make the UI unresponsive.