

Product Description

Force Sensitive Resistor are resistive sensor exhibiting vary resistance that responds to force applied to the sensing area. As force on the sensor is increased, resistance is decreased.

For the single-zone sensors, as the sensor is a Two-terminal device that can essentially be treated as a variable resistor whose value is controlled by applied force, and also a switch whose threshold is controlled by applied force and setting up.

The sensors are made up of robust polyester film, high-conductive material and Nano-sized force sensing material. The top layer of the sensor consists of the area of force sensitive layer on a flexible film. And bottom layer is comprised of conductive circuit traces on a flexible film. And the above two layers are stick together by spacer adhesive and active area is without adhesive. When the active area is applied force, force sensitive layer on the top layer shunts the circuit traces on the bottom, varying resistance output terminals.

- Static / dynamic pressure sensing
- Quick response
- Durable long life
- Customized design

Technical Data And Physical Properties

Thickness	0.42mm
Shape	Flexible
Actuation force	10g Res.<=200KΩ
Sensitivity range	10g to 10Kg
Resolution	continuous
Non-actuated resistance	>10M Ω
Response time	<10us
Operating temperature	-40℃ ~+ 85℃
Life time	>1 million
Repeatability Same part	+/-5%, Average R@1000g
Repeatability part to part	+/-10% Average R@1000g
Hysteresis	+ 10%, @1000g, (RF+ - RF-)/FR+
EMI	Generates no EMI
EDS	not ESD sensitive
Drift	<10%, 2.5kg load, 24H
RoHS	

Force curve

The following plot shows an example response resistance curve, when the sensor actuated by a force curve tester.

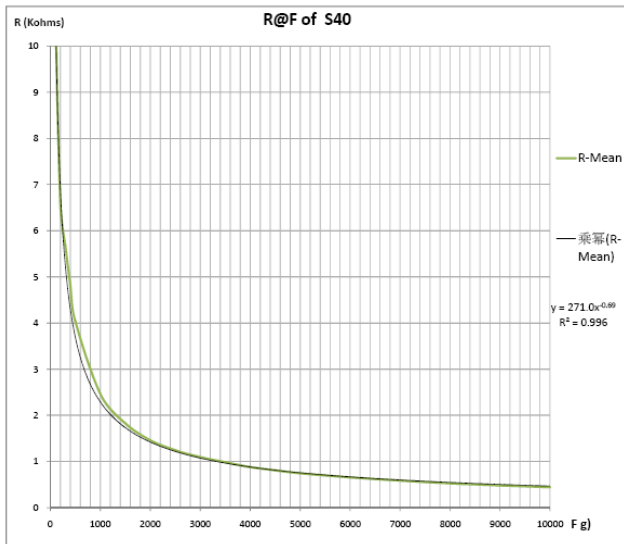

The following plot shows an near-linear curve whose axes value treated by log10.

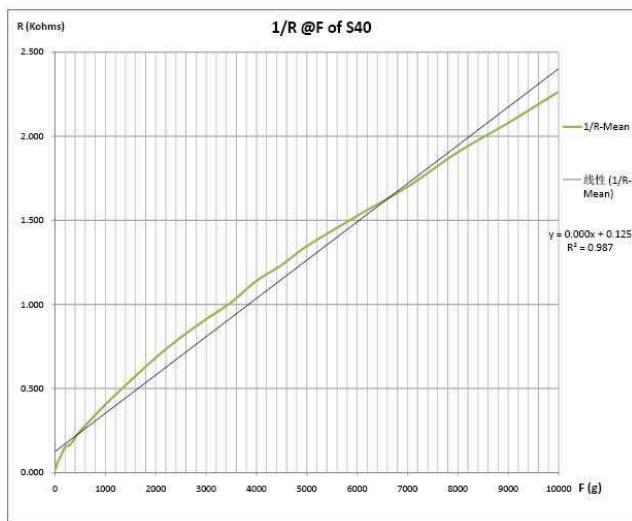

Application Circuit

1. Voltage Divider

The sensor is placed in series with a fixed resistor (R_0), and output voltage is measured across R_0 . It is given by $V_{out} = V_{cc} \cdot R_0 / (R_0 + R_s)$.

How to define the fixed resistor value, Basically, R_0 is 1/3 to 1/2 of the resistance range of R_s . What's more, if R_0 is appropriate, you can get a near-linear curve of Force vs V_{out} in a special force range. Depending on the impedance requirements of the measuring circuit, the voltage divider could be followed by an

op-amp.

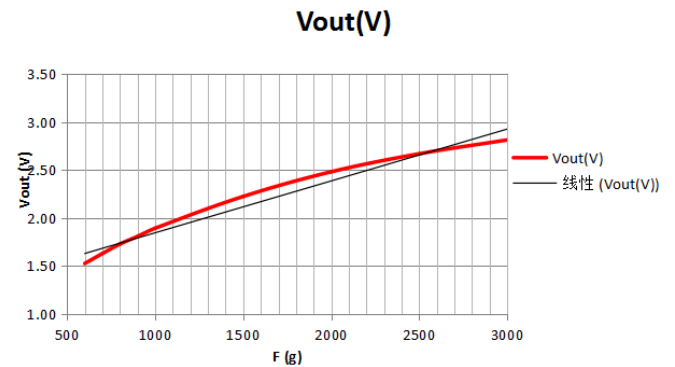
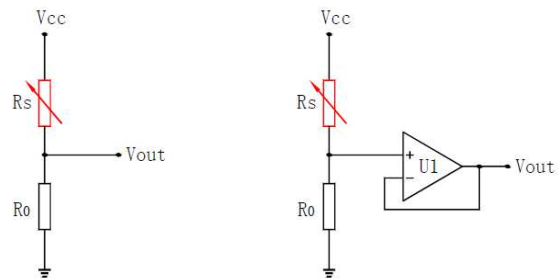

2. Force Threshold Switch

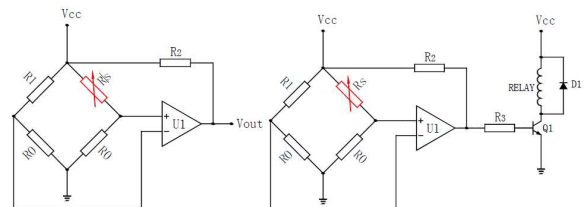

This is an ideal circuit for applications that require on-off switching at a specified force.

It consists a Wheatstone bridge circuit and a voltage comparator.

When apply force and R_s becomes to be lower than R_1 , lead $U1+$ to be higher than $U1-$, and V_{out} becomes to be high. This high level signal can used to be trigger signal of following devices, for example, it can trigger a relay, and then control LEDs, buzzer warning, motor and other load devices.

Mechanical data of sensor S40-ST

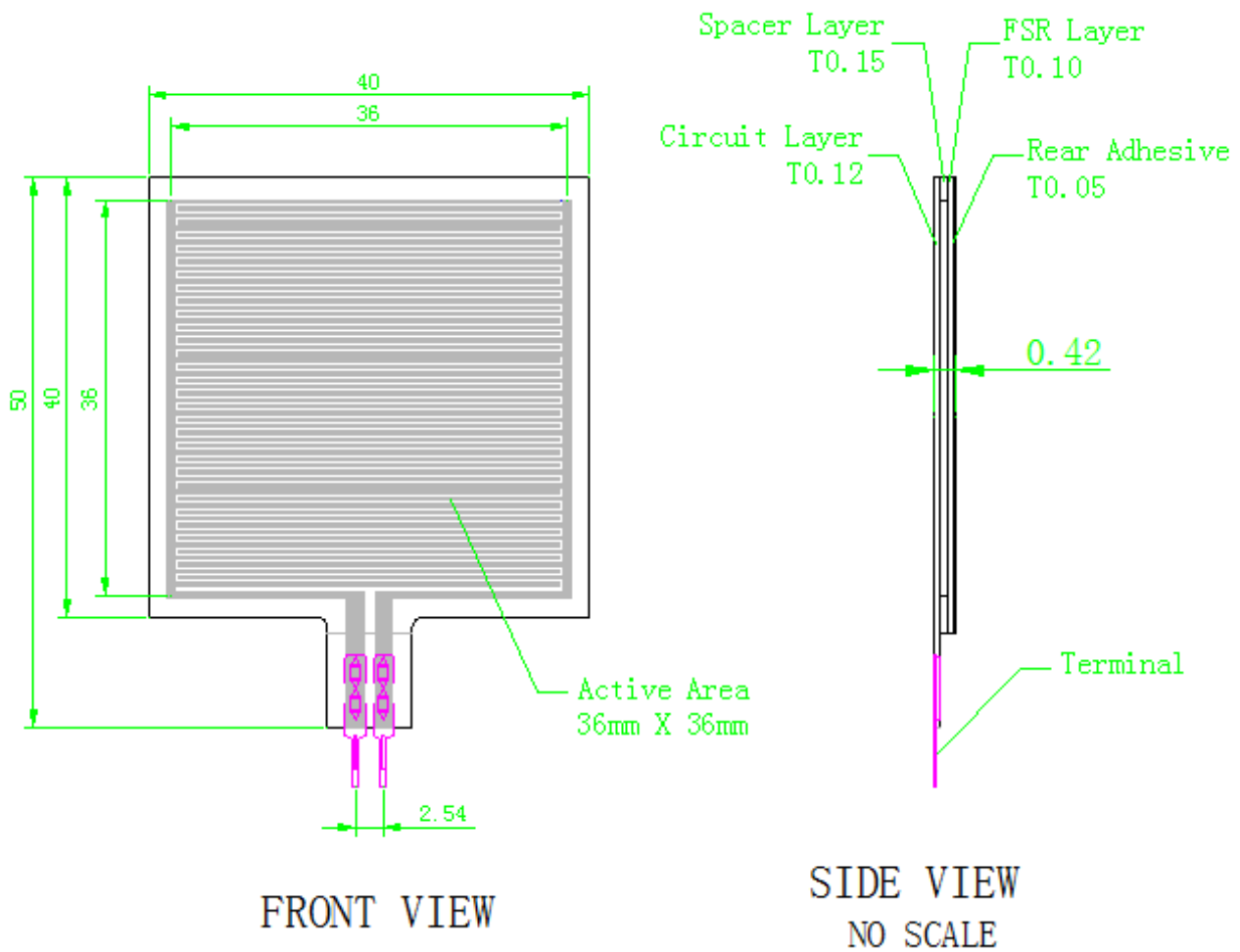

Note:

The above information is considered correct and is prepared for professional, competent users who are able to properly evaluate and use these data. Film sensor Technology Co. Ltd does not guarantee the accuracy of these data, the use of the damage occurred in the process of no responsibility.

Product Description

Force Sensitive Resistor are resistive sensor exhibiting vary resistance that responds to force applied to the sensing area. As force on the sensor is increased, resistance is decreased.

For the single-zone sensors, as the sensor is a Two-terminal device that can essentially be treated as a variable resistor whose value is controlled by applied force, and also a switch whose threshold is controlled by applied force and setting up.

The sensors are made up of robust polyester film, high-conductive material and Nano-sized force sensing material. The top layer of the sensor consists of the area of force sensitive layer on a flexible film. And bottom layer is comprised of conductive circuit traces on a flexible film. And the above two layers are stick together by spacer adhesive and active area is without adhesive. When the active area is applied force, force sensitive layer on the top layer shunts the circuit traces on the bottom, varying resistance output terminals.

- Static / dynamic pressure sensing
- Quick response
- Durable long life
- Customized design

Technical Data And Physical Properties

Thickness	0.42mm
Shape	Flexible
Actuation force	10g Res.<=200KΩ
Sensitivity range	10g to 10Kg
Resolution	continuous
Non-actuated resistance	>10M Ω
Response time	<10us
Operating temperature	-40℃ ~+ 85℃
Life time	>1 million
Repeatability Same part	+/-5%, Average R@1000g
Repeatability part to part	+/-10% Average R@1000g
Hysteresis	+ 10%, @1000g, (RF+ - RF-)/FR+
EMI	Generates no EMI
EDS	not ESD sensitive
Drift	<10%, 2.5kg load, 24H
RoHS	

Force curve

The following plot shows an example response resistance curve, when the sensor actuated by a force curve tester.

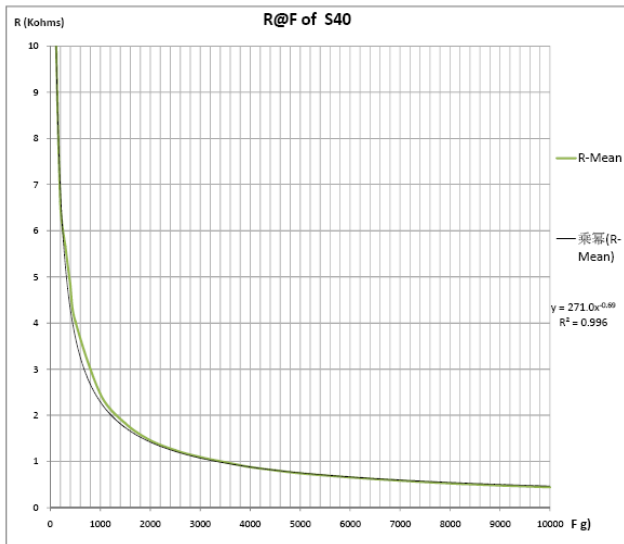

The following plot shows an near-linear curve whose axes value treated by log10.

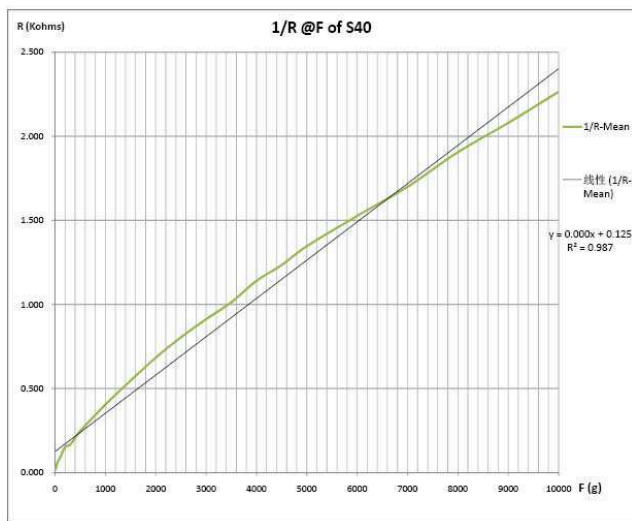

Application Circuit

1. Voltage Divider

The sensor is placed in series with a fixed resistor (R_0), and output voltage is measured across R_0 . It is given by $V_{out} = V_{cc} \cdot R_0 / (R_0 + R_s)$.

How to define the fixed resistor value, Basically, R_0 is 1/3 to 1/2 of the resistance range of R_s . What's more, if R_0 is appropriate, you can get a near-linear curve of Force vs V_{out} in a special force range. Depending on the impedance requirements of the measuring circuit, the voltage divider could be followed by an

op-amp.

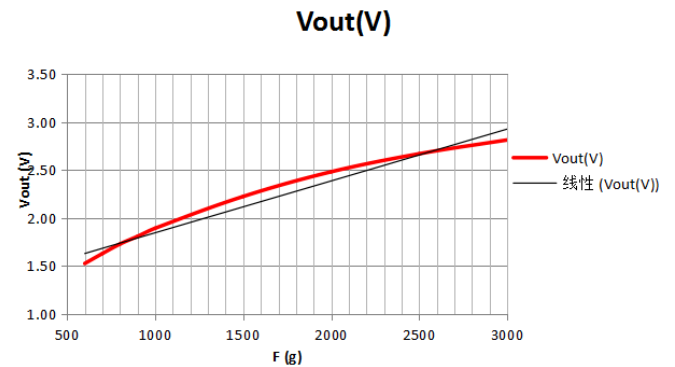
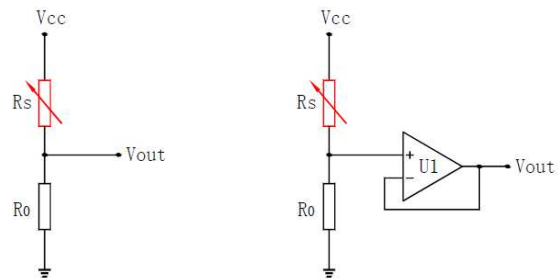

2. Force Threshold Switch

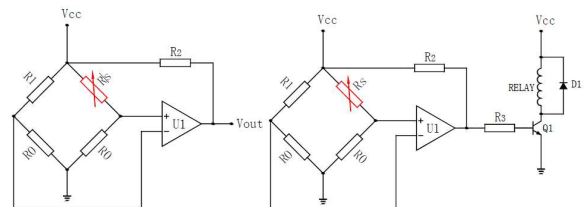

This is an ideal circuit for applications that require on-off switching at a specified force.

It consists a Wheatstone bridge circuit and a voltage comparator.

When apply force and R_s becomes to be lower than R_1 , lead $U1+$ to be higher than $U1-$, and V_{out} becomes to be high. This high level signal can used to be trigger signal of following devices, for example, it can trigger a relay, and then control LEDs, buzzer warning, motor and other load devices.

Mechanical data of sensor S40-ST

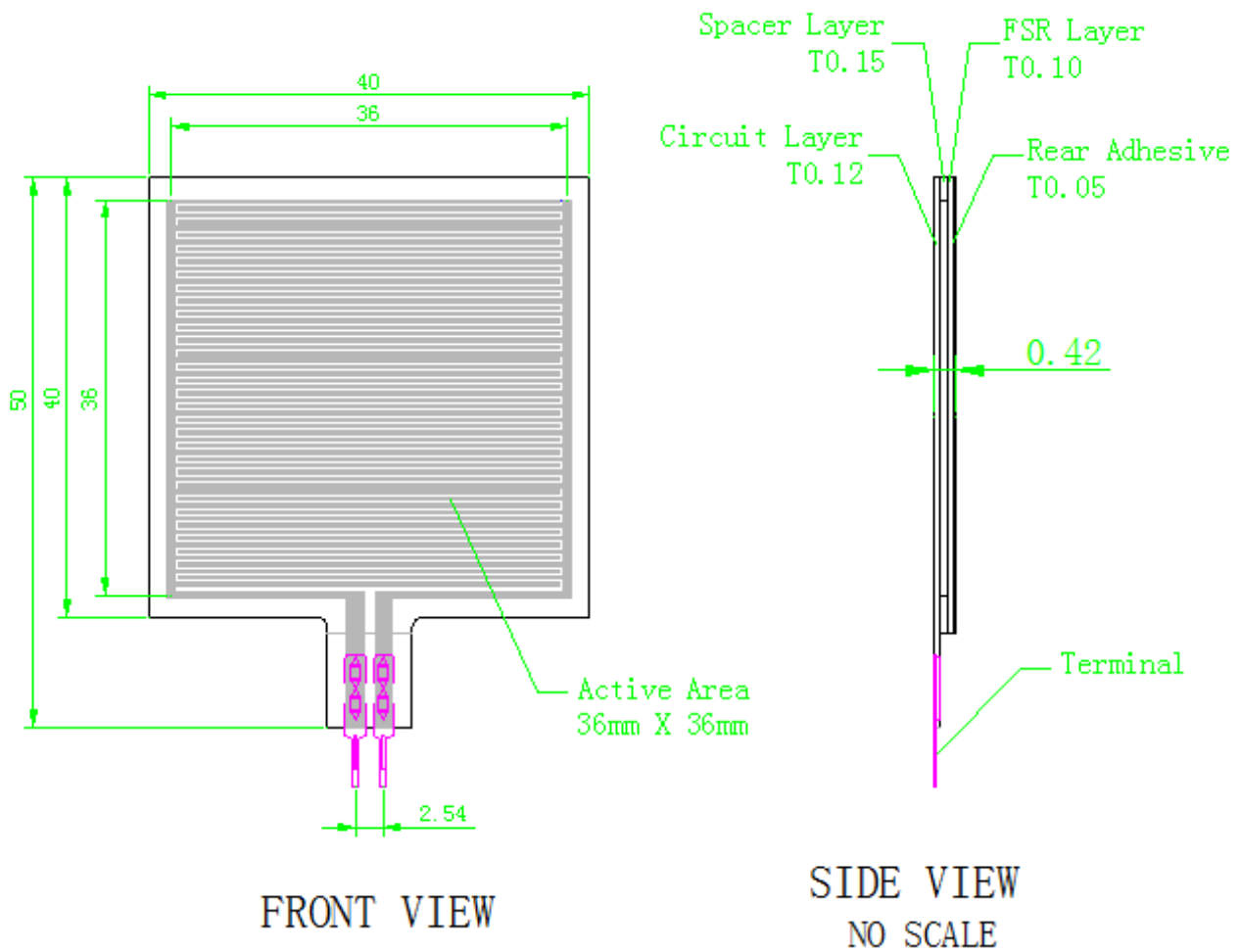

Note:

The above information is considered correct and is prepared for professional, competent users who are able to properly evaluate and use these data. Film sensor Technology Co. Ltd does not guarantee the accuracy of these data, the use of the damage occurred in the process of no responsibility.