

DUAL OPERATIONAL AMPLIFIERS

Description

The GL4558 is dual general purpose operational amplifiers with half electrically similar to μ A741 except that offset null capability is not provided.

The high common-mode input voltage range and the absence of latch-up make these amplifiers ideal for voltage follower application.

The devices are short circuit protected and the internal frequency compensation ensures stability without external components.

These are characterized for operation from 0°C to 70°C.

PIN Configuration

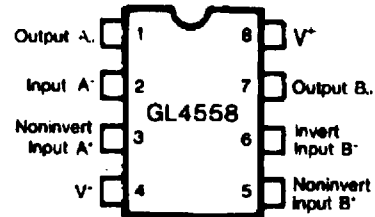

Features

- Short-Circuit Protection
- Wide common-mode and differential voltage ranges
- No frequency compensation required
- Low power consumption
- No latch-up
- 3 MHz unity gain bandwidth guaranteed
- Gain and phase match between amplifiers

Absolute Maximum Ratings

PARAMETER	GL4558	UNIT
Supply Voltage	± 18	V
Differential Input Voltage	± 30	V
Input Voltage	± 15	V
Power Dissipation	570	mW
Operating Temperature Range	0 to 70	°C
Storage Temperature Range	-55 to 125	°C
Lead Temperature	260	°C

Schematic Diagram (Each Amplifier)

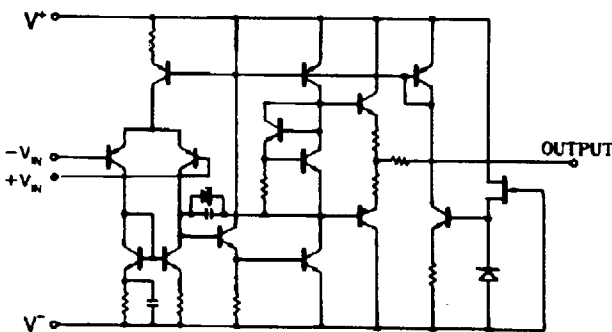

Electrical Characteristics ($V^+ = +15V$, $V^- = -15V$, $T_A = 25^\circ C$)

PARAMETER	SYMBOL	TEST CONDITIONS	GL4558				UNIT
			MIN	TYP	MAX	MIN	
Input Offset Voltage	V_{IO}	$R_s \leq 10k\Omega$	—	± 0.5	± 5	—	mV
Input Offset Current	I_{IO}		—	± 5	± 200	—	nA
Input Bias Current	I_{IB}		—	50	500	—	nA
Input Resistance	r_i		0.3	2.0	—	0.3	M Ω
Large-Signal Voltage Gain	A_V	$R_L \geq 2k\Omega$, $V_C = \pm 10V$	20	200	—	20	V/mV
Output Voltage Swing	V_{OM}	$R_L \geq 10k\Omega$	± 12	± 14	—	± 12	V
		$R_L \geq 2k\Omega$	± 10	± 13	—	± 10	V
Input Common-Mode Voltage range	V_{ICR}		± 12	± 13	—	± 12	V
Common Mode Rejection Ratio	CMRR	$R_s \leq 10k\Omega$	70	90	—	70	dB
Supply Voltage Rejection Ratio		$R_s \leq 10k\Omega$	—	30	150	—	$\mu V/V$
Supply Current	I_{CC}		—	2.3	5.6	—	mA
Slew Rate	SR	$R_L \geq 2k\Omega$	—	1.0	—	—	V/ μs
Power Consumption	P_C	$R_L = \infty$	—	100	170	—	mW
Input Noise Voltage	V_N	$R_s = 1k\Omega$ $f = 30Hz \sim 30KHz$	—	2.5	—	—	μV_{rms}
Source Current	I_{source}		—	40	—	—	mA
Sink Current	I_{sink}		—	40	—	—	mA

Typical Performance Curves

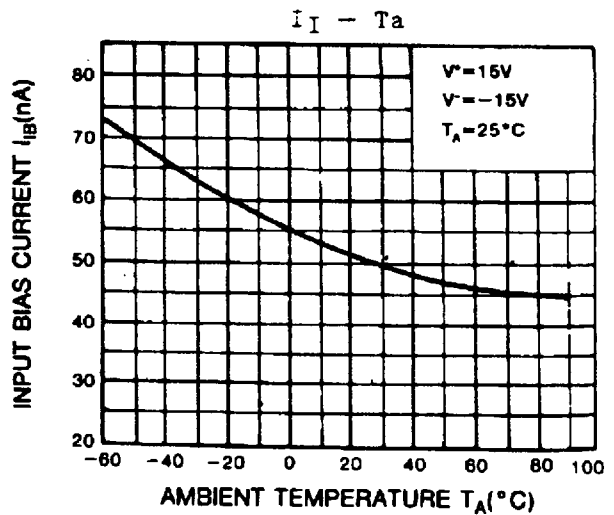
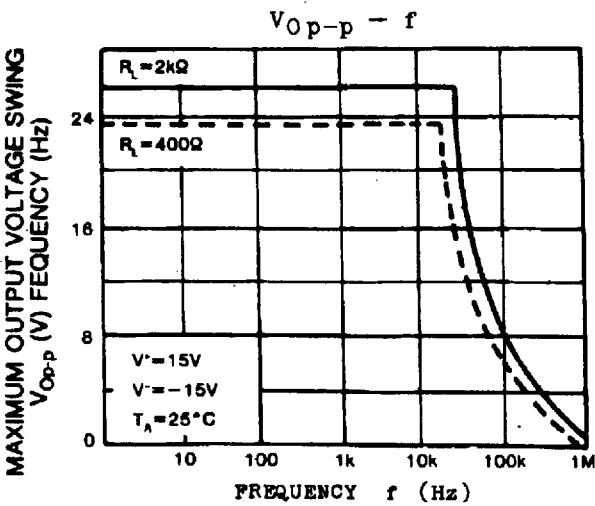
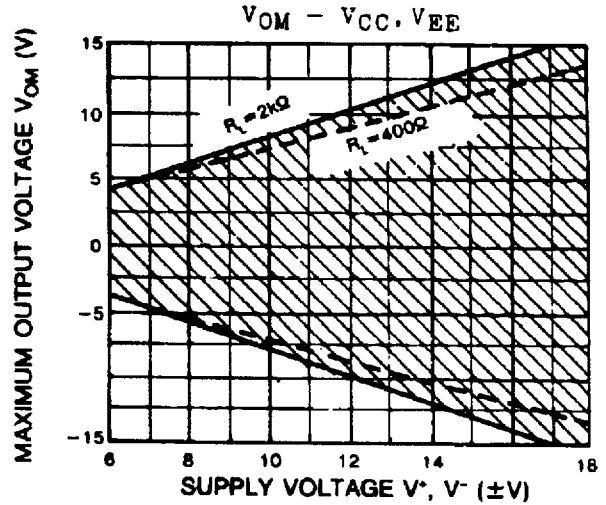
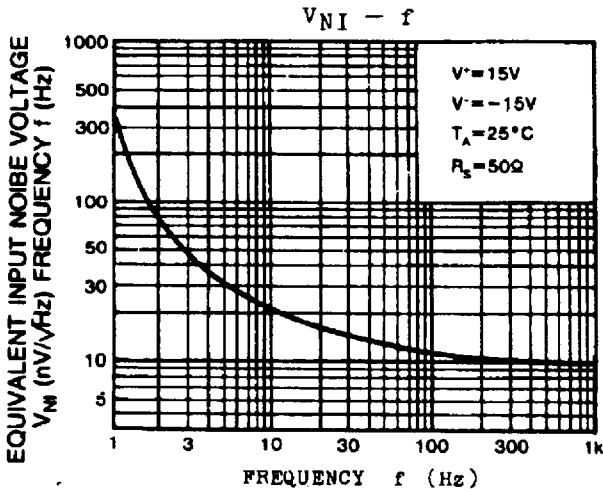
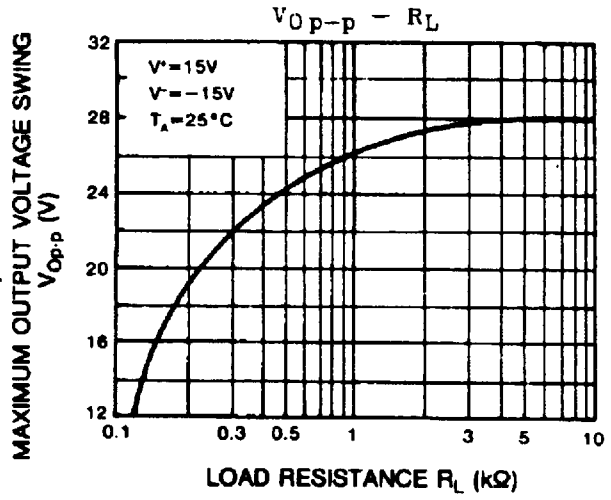
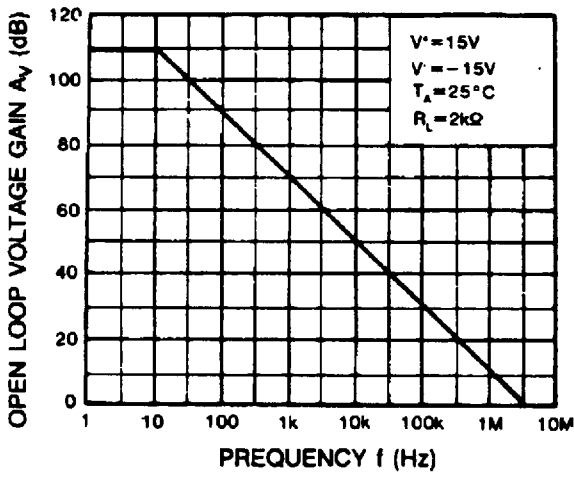

Typical Applications

Voltage Follower

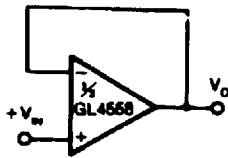

Lamp Driver

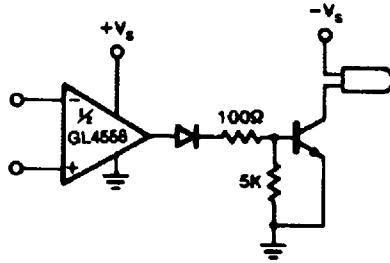

Comparator With Hysteresis

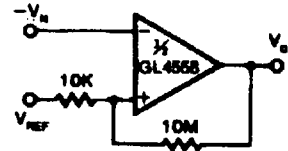

Power Amplifier

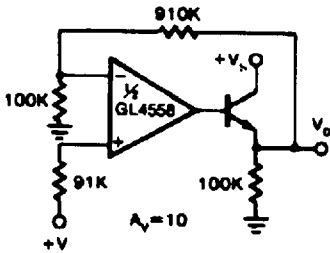

Squarewave Oscillator

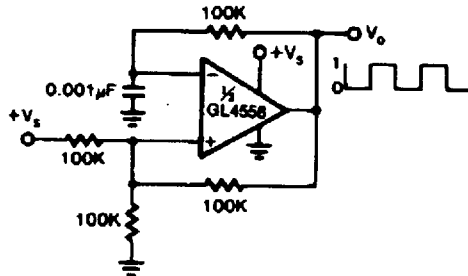

DC Coupled 1kHz Low-Pass Active Filter

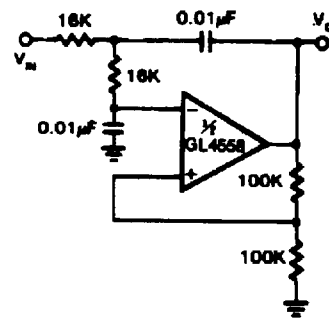

1kHz Bandpass Active Filter

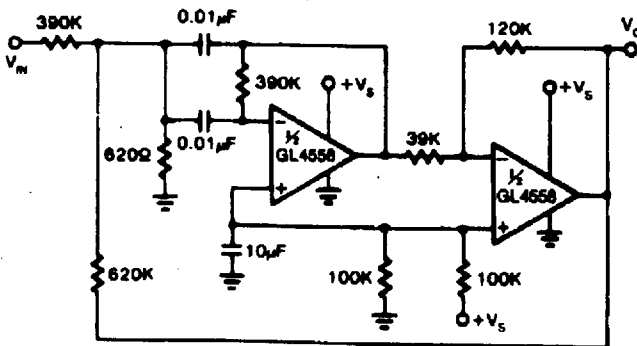

AC Coupled Inverting Amplifier

